

# WM1

## USER MANUAL

The user manual is available on  
<https://viofo.com/en/content/42-help-and-support/>

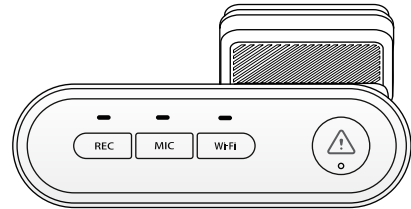

# Table of Contents

<b>1. Product Overview</b> ----- 2	<b>7. System Settings</b> ----- 20
Standard Items	Video Setting
Optional Accessories	System Setting
Product Diagram	Other
<b>2. Installation</b> ----- 6	<b>8. Firmware Upgrade</b> ----- 26
Insert / Remove the Memory Card	<b>9. Notice</b> ----- 26
Install the Dashcam	<b>10. Customer Service</b> ----- 29
Install the Static Sticker	
Remove the Dashcam	
<b>3. Dash Cam Recording Operation</b> ----- 12	
Power On / Off	
Loop Recording	
Emergency Recording	
Disable / Enable Audio Recording	
Parking Mode	
<b>4. Playback and Manage Videos</b> ----- 14	
Playback Video on VIOFO APP	
Playback Video on PC	
Video File Storage Location	
<b>5. Review and Control on Smartphone</b> ---15	
Connect to Smartphone	
APP Layout Overview	
<b>6. Install Optional Accessories</b> -----18	

## Product Overview

### Standard Items



Dashcam



Car Charger Adapter

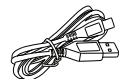

Type-C Data Cable



Trim Removal Tool



Spare Mount Sticky Pad



Windshield Static Stickers x2

## Optional Accessories



Circular Polarizing  
Lens Filter



Bluetooth Remote  
Control



HK4  
Hardwire Kit



MicroSD Card

## Product Diagram

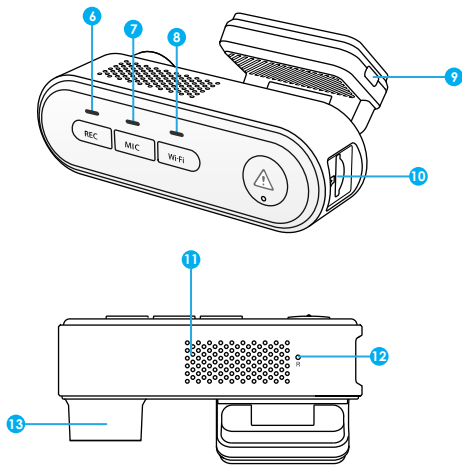
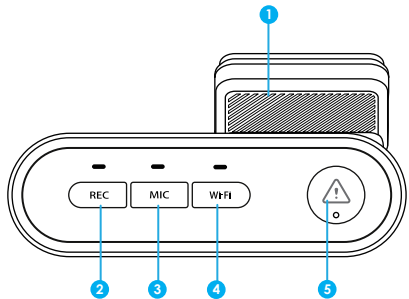



1. GPS Module
2. Power On | OFF  
Recording Start | Stop
3. Microphone On | OFF
4. Wi-Fi On | OFF
5. Video Protect
6. Recording Status Indicator
7. Microphone Status Indicator

8. Wi-Fi Status Indicator
9. Power In / microSD Card Reader  
Mode (computer)
10. microSD Card Slot
11. Heat-dissipation Block
12. Reset Hole
13. Lens

## LED Indicators

LED light	LED Status	Behavior
REC	Solid Red	Recording
	Flashing Red	Not Recording Updating Firmware
MIC	Solid Red	Audio Recording On
	Red Off	Audio Recording Off
Wi-Fi	Solid Blue	Wi-Fi Connected
	Flashing Blue	Wi-Fi On and Waiting Connecting
	Blue Off	Wi-Fi Disabled

## Buttons and Icons

Buttons	Behavior
REC	Long press to Power ON / OFF Click once to start / stop recording
MIC	Click once to disable / enable audio recording
Wi-Fi	Long press to turn on / off Wi-Fi
	Click once to lock the file being recorded Recording pause, long press to format the card
Wi-Fi + 	Recording pause, hold both buttons to turn on Bluetooth pairing mode
MIC + 	Recording pause, hold both buttons to reset the camera to default settings

## Installation

### 1. Insert / Remove the Memory Card

#### ■ Insert the memory card

Ensure the camera is turned off. Hold the memory card in the orientation shown, slide it into the card slot until you hear a click.

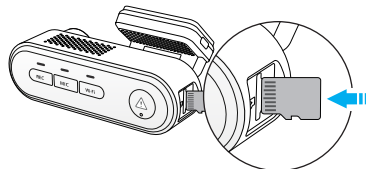

#### ■ Remove the memory card

Ensure that the camera is turned off, and then push the edge of the memory card with your fingernail. The card will spring out far enough to be removed.

#### Note:

- The microSD card is sold separately. The microSD card must have a Class-10 or UHS-I rating and the capacity is up to 512GB.
- We recommend that you buy VIOFO industrial grade microSD card for extended endurance, excellent performance and reliability.
- Memory card must be formatted before first use. Please format the card on a computer or in the camera to the exFAT or FAT32 file system.
- Please unplug the power cable before inserting or removing the microSD card.
- Inserting or removing the microSD card while recording may destroy the files.

## ■ Format the memory card

### Format the memory card in the camera

To format the card in the camera, either use the VIOFO App and the format option in the Settings, or alternatively long press the [  ] button.

### Format the memory card using a computer

To format the memory card on your computer, follow your computer's user manual.

For deep formatting of the memory card, you can also download the GUIFormat tool from our official website:

<https://viofo.com/download/guiformat.exe>

## 2. Install the Dashcam

1. Select a location on the windshield behind the rear-view mirror where the camera will not obstruct the driver's view while driving.

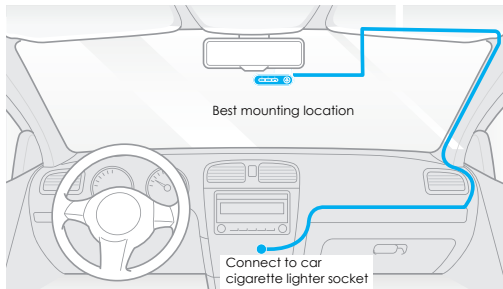

2. Wipe clean the installation surface of the windshield with a dry cloth, it must be grease free for the sticky pad to stick firmly.

3. Mount the dashcam directly to the windshield with the sticky pad, or attach the static sticker to the selected location ( Refer to guide on page 10 ).

4. Peel the protection film off the sticky pad and camera lens.

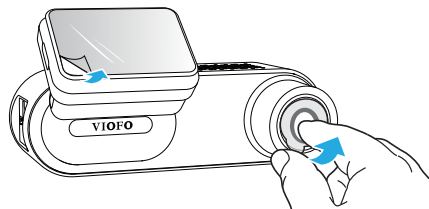

5. Fix the camera on the selected location.

6. Adjust the Bracket Angle

Adjust the angle (about 60°) of the bracket up / down according to the needs of video recording.

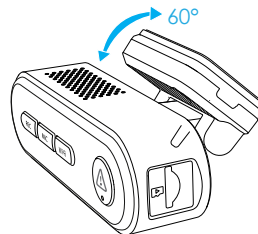

### 7. Connect to Power

Insert the car charger USB cable's male port into the camera mount's USB Type-C port. Plug the USB power adapter into your vehicle's 12V / 24V female power socket.

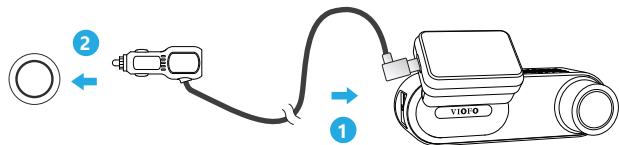

#### Tips:

1. Do not install / mount the camera in a location that interferes with the driver's visibility and safety.
2. Install / mount the camera close to the rearview mirror so that both sides of the scene being recorded are equally covered by the camera's FOV (field of view).
3. To ensure a clear view on rainy days, the lens should be positioned within the windshield wiper's sweeping range.
4. Do not install / mount the camera on or near airbag panels.
5. Installation / mounting location should not be affected by sun control film (window tint). There should not be any other electronic equipment close to the camera for optimal performance.

#### Note:

Do not install / mount the camera or cables near an airbag panel or within the airbag's working range. The manufacturer is not liable for any injury or death caused by deployment of the airbag.

### 3. Install the Static Sticker (Optional)

1. Wipe clean the surface of the windshield before installation.
2. Peel the red sign protective film off the static sticker, then attach the sticker to the windshield. Press it for a few seconds, making sure no bubbles are left.

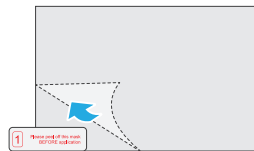

3. Peel the green sign protective film off the static sticker.

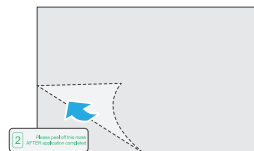

4. Peel the protection film off the sticky pad on the mount, and attach it to the sticker. Press the camera hard for a few seconds, making sure it is attached firmly.

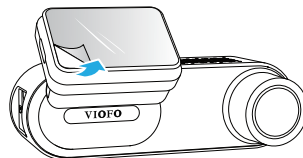

## 4. Remove the Dashcam

### Remove the Dashcam

To remove the camera from its bracket, slide the camera to the right and pull the camera out of the mounting bracket.

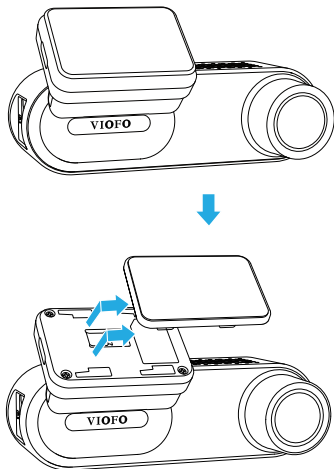

#### Note:

When you want to plug in and unplug the camera, please turn it off first.

## Dash Cam Recording Operation

### Power On/Off

1. When you start the engine, the camera will turn on and begin recording automatically.
2. When you turn off the engine or unplug the charging cable from the power adapter, the camera will stop recording and turn off.
3. Long press [ **REC** ] button to power on or off the camera.

### Loop Recording

1. Insert a microSD card into the camera's card slot and automatic loop recording will begin once the camera detects power.
2. Time frame for each video file is 1 / 2 / 3 / 5 / 10 minutes.
3. When there is insufficient space on the MicroSD card, loop recording will automatically overwrite the oldest files (one by one).
4. Loop recording files are saved to SD card: \ DCIM \ MOVIE folder.

### Emergency Recording

1. Automatic emergency recording

When the G-sensor is activated and a collision occurs, current footage will be locked automatically to avoid being overwritten by loop recording.

2. Manual emergency recording

Pressing the [  ] button during footage recording will lock current footage to avoid being overwritten by loop recording.

## Note:

The collision sensing feature can be adjusted in settings under the "G-sensor" option via VIOFO App. Locked files are saved to SD card: DCIM \ Movie \ RO

## Disable / Enable Audio Recording

Pressing the [MIC] button once to turn off / on audio recording, [ MIC ] LED light will be off / solid Red.

## Parking Mode

There are three options for parking mode.

### 1. Auto Event Detection

The camera will automatically record a video sequence while a moving object is being detected during parking mode. It will stop recording when no new movement is detected.

### 2. Time Lapse Recording

Time lapse record a video at low frames at 1 / 2 / 3 / 5 / 10 fps, it keeps recording continuously without audio recorded.

Note: Audio cannot be recorded in time-lapse mode.

### 3. Low Bitrate Recording

This mode uses low bitrate to record video and audio, and uses small file sizes for continuous recording.

**Note:** Parking mode provides surveillance of your parked vehicle only when the engine is off and the USB Type-C Hardwire Kit is used to provide continuous power. The Hardwire Kit also protects your car battery from being drained. We recommend buying the VIOFO HK4 ACC hardwire kit cable for parking mode recording.

## Playback and Manage Videos

### Playback Video on VIOFO APP

Long press the Wi-Fi button to enable Wi-Fi. Connect Wi-Fi on your phone first. Open VIOFO app and choose "Connect your camera" to use your phone to control the dashcam. You can play and manage files through the APP. You can check the app introduction refer to [Review and Control on Smartphone].

### Playback Video on PC

1. Remove memory card from dashcam.  
Before removing the memory card, make sure you have switched off the Dashcam.
2. Insert the memory card into a SD card adapter or card reader connected to your PC.
3. Open the DCIM folder, using VLC or another video player to playback the video.

**Note:** For your PC with a microSD slot, you can directly insert the memory card into it.

### Video File Storage Location

Recording Mode	Behavior
Loop Recording ( Including Motion Detection )	DCIM \ Movie
Emergency Recording ( Locked Video )	DCIM \ Movie \ RO
Parking recording ( Auto Event Detection / Time-lapse Recording / Low Bitrate Recording )	DCIM \ Movie \ Parking
Snapshot	DCIM \ Photo

## Review and Control on Smartphone

### Connect to Smartphone

The VIOFO app allows you to control your camera remotely by using a smartphone. Features include full camera control, live preview, playback and video recording.

#### Android Device

Android users can download the app from Google Play, or download the APK directly from our official website:  
<https://viofo.com/en/content/13-app/>

#### IOS Device

IOS users can download the app from the App store.



Download on the  
App Store



GET IT ON  
Google Play

#### Connect VIOFO APP

Long press the [Wi-Fi] button to turn on the Wi-Fi. Wi-Fi name (SSID) of Wi-Fi is VIOFO\_WM1\_XXXX, Wi-Fi default password is 12345678. When the Wi-Fi is on, Wi-Fi Status LED will be flashing blue.

- **Step 1:** Use the phone to connect WM1 Wi-Fi. When the phone is connected with the dashcam, the LED light on the camera shows solid blue.
- **Step 2:** Open VIOFO app and choose "Connect your camera" to use your phone to control the dashcam.
- **Step 3:** Now you can see the live view of both cameras. You can change the settings and check the files on the app.

### APP Layout Overview

Choosing "Connect your camera" to use your phone to control the dashcam.



- 1 - Menu
- 2 - Home Page
- 3 - Downloaded Video
- 4 - VIOFO Official Facebook Page

- 5 - Official Support
- 6 - Firmware Update
- 7 - VPN connection

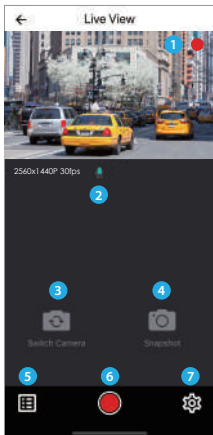

- 1 - Live Video
- 2 - Audio Recording Status
- 3 - Switch Camera Video Source (Not Applicable)
- 4 - Take a Video Snapshot
- 5 - Go to Video File Lists
- 6 - Start / Stop Recording
- 7 - Go to System Settings

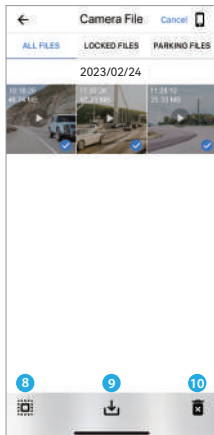

### Preview Video

- 8 - Video File Lists
- 9 - Download Video Files
- 10 - Delete Video Files

## Install Optional Accessories

### Install CPL

The CPL (Circular Polarizing Lens) can be used to reduce reflections and glare from the window glass and road surfaces that can otherwise damage image quality, this works in the same way as polarized sunglasses, getting more saturated and beautiful video.

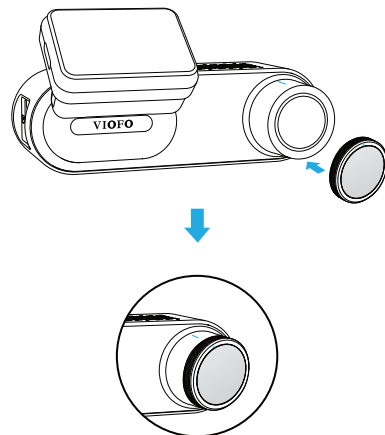

When installing the CPL, you need to align the white mark on the CPL with the corresponding mark on the camera.

### Install Bluetooth Remote Control

The remote control has an adhesive mount on the back, choose a suitable location on your dashboard to stick it to. Power on the camera, press [ **Wi-Fi** + **△** ] buttons to enter Bluetooth pairing mode and then press the video lock button on the remote control for 3 seconds to pair it with the camera, the LED indicator on the remote will turn blue if successfully paired.

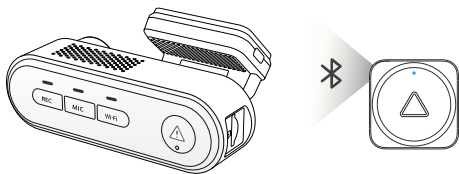

Camera setup is available in the VIOFO App. Connect the App as above, stop recording, then enter the settings menu.

### Video Setting

- **Video Resolution:**

2560 \* 1440P 30fps

1920 \* 1080P 30fps

- **Time-lapse Recording:** Off / 1 / 2 / 3 / 5 / 10 fps.

Record video from frames captured at specific time intervals to conserve memory and reduce the time it takes to review video. The default is off.

- **Loop Recording:** Off / 1 / 2 / 3 / 5 / 10 minutes.

Recording will begin automatically after powering on with a microSD card in the device. Each recorded file is up to one minute long, with old footage being replaced when microSD card storage is full.

- **Recording Audio:**

Turn on and off the microphone. This can also be changed during recording by pressing the [ **MIC** ] button.

- **Exposure Value:**

Adjusting the value of the EV (Exposure Value) properly can create better footage under different light sources. It ranges from -2.0 to +2.0. The default is set at 0.0.

- **WDR (Wide Dynamic Range):**

On / Off. The dynamic range is the ratio of the brightest portion of the image to the darkest portion of the image. WDR enables the camera to deliver video with a near perfect exposure in varying lighting situations.

- **G-Sensor:**

The G-sensor measures shock forces and locks the video recorded at the time. The settings from "low to high" determine the amount of force needed to lock the file from being overwritten. We recommend that you set it at low.

- **Date Stamp:**

On / Off. Imprint the time and date on the recorded video.

- **Bitrate:** Low / Normal/ High / Maximum.

You can set the bitrate for video. High bitrate may improve the quality and smoothness of the video, especially when recording fast motion or high contrast scenes. Using high bitrate mode may decrease the amount of recording time available on your memory card. Using a low bitrate will save space and record for longer time.

## System Setting

---

- **Time Zone:** Set the current time zone for GPS time and date calibration.

Note: the time zone must be manually adjusted for daylight savings.

- **Time Synchronization:** Time synchronization with mobile phone.

- **Date Format:** You can choose the date format of the camera.

- **Boot delay:** The camera will boot seconds delay when powered on. The settings are off / 5s / 10s.

- **Parking Mode:** There are 3 options under parking mode:

- ① Auto Event Detection

The camera will automatically record a video sequence while a moving object is detected during parking. It will stop recording without new movements.

- ② Time Lapse Recording

Time lapse records a video at low frames at 1 / 2 / 3 / 5 / 10 fps, it keeps recording continuously without audio recorded.

- ③ Low Bitrate Recording

This mode uses low bitrate to record video and audio, and uses small file sizes for continuous recording.

**Note:**

1. We recommend buying VIOFO HK4 ACC hardwire kit cable for parking mode recording.
2. In case you park the car outside in hot summer, we highly recommend time lapse recording mode. If the temperature inside the car goes above 60°C, we advise turning off the dashcam to avoid recording errors or even irreversible damages.

- **Parking Recording Timer:**

"Off" means the camera will keep recording until the hardwire kits cut the power supply.

"1 hour" means the camera will shut down after it gets into parking mode for 1 hour.

- **Enter Parking Mode Timer:**

Set the timer for entering parking mode. (Only for hardwire cable, if you use external battery, this function will not work.)

"OFF" means the camera will enter parking mode right away when the engine is off.

"90s" means the camera will enter parking mode 90 seconds after engine is off.

- **Parking G-Sensor:**

The G-sensor detects significant or sudden movement (such as an impact or collision), it will trigger an event recording. We suggest setting it to High sensitivity in parking mode recording.

- **Parking Motion Detection:**

Adjusts the sensitivity of the motion detection so minor motion caused by wind or rain doesn't trigger a recording.

- **Image Rotate:**

Turn the image upside down. You can set the camera image rotation.

- **Image Mirror:**

Change the image reversely.

- **Notification Sounds:**

Off / Button beep only / Startup sound only / All on.

You can enable/disable the button and startup sounds.

- **Voice Notification:**

turn on / off the voice notification.

- **GPS:**

Turn on / off GPS logger. A GPS module is used to include the location data in the recorded videos. If disabled, your camera will no longer measure your speed and position; nor synchronize the time / date. (Only available when connecting with GPS signal) Please use "Dashcam Viewer" to playback videos and to visualize your position and speed on your computer.

- **Speed Unit:**

Kilometer per hour (KMH) and miles per hour (MPH) are available for speed unit.

- **GPS Info Stamp:**

Imprint the GPS information on the recorded video.

- **Camera Model Stamp:**

Imprint the camera model on the recorded video.

- **Frequency:**

Set it to minimize flickering and banding in the recorded video.

- **Format SD Card:**

The operation will delete all data on the MicroSD card.

Note: Once you format the card, all information will be deleted and unrecoverable. Make sure you back up all files that you need before formatting.

- **Reset Camera Settings:** Reset all settings to default values.
- **Wi-Fi Name (SSID):** Change Wi-Fi name.
- **Wi-Fi Password:** Change Wi-Fi Password. Wi-Fi default password is 12345678.
- **Custom Text Stamp:** Imprint the custom text on the recorded video.
- **Car License Number:** Imprint the car number on the recorded video.
- **Free Space on Card:** Show the remaining storage space on the microSD card.

## Other

---

- **App Version:** Check the current firmware version of the APP.
- **Firmware:** Check the current firmware version of the camera.

## Firmware Upgrade

Follow the instructions on this website to upgrade the firmware:  
(<https://viofo.com/content/42-help-and-support/>)

### Note:

- Before using a microSD card to upgrade the firmware, formatting the card in the camera is necessary to ensure stable read and write operation.
- Do not unplug or power off the camera during a firmware upgrade, it may cause the camera to subsequently fail to boot.

## Notice

### FCC Statement

This equipment has been tested and found to comply with the limits for a Class B digital device, pursuant to part 15 of the FCC Rules. These limits are designed to provide reasonable protection against harmful interference in a residential installation. This equipment generates, uses and can radiate radio frequency energy and, if not installed and used in accordance with the instructions, may cause harmful interference to radio communications. However, there is no guarantee that interference will not occur in a particular installation. If this equipment does cause harmful interference to radio or television reception, which can be determined by turning the equipment off and on, the user is encouraged to try to correct the interference by one or more of the following measures:

- Reorient or relocate the receiving antenna.
- Increase the separation between the equipment and receiver.

- Connect the equipment into an outlet on a circuit different from that to which the receiver is connected.
- Consult the dealer or an experienced radio / TV technician for help.

**Caution:**

Any changes or modifications to this device not explicitly approved by the manufacturer could void your authority to operate this equipment. This device complies with part 15 of the FCC Rules. Operation subjects to the following two conditions:

- (1) This device may not cause harmful interference.
- (2) This device must accept any interference received, including interference that may cause undesired operation.

Shenzhen VIOFO Technology Co., Ltd, declares that this Radio Frequency peripheral is in compliance with the essential requirements and other relevant provisions of Directive 1999/5/EC.

This equipment complies with FCC radiation exposure limits set forth for an uncontrolled environment. This equipment should be installed and operated with minimum distance 20cm between the radiator & your body.

**IC warning****- English:**

This device complies with Industry Canada licence-exempt RSS standard(s). Operation is subject to the following two conditions: (1) This device may not cause interference, and (2) This device must accept any interference, including interference that may cause undesired operation of the device.

**- French:**

L'émetteur/récepteur exempt de licence contenu dans le présent appareil est conforme aux CNR d'Innovation, Sciences et Développement économique Canada applicables aux appareils radio exempts de licence. L'exploitation est autorisée aux deux conditions suivantes :

- 1) L'appareil ne doit pas produire de brouillage;
- 2) L'appareil doit accepter tout brouillage radioélectrique subi, même si le brouillage est susceptible d'en compromettre le fonctionnement.

This equipment complies with IC RSS-102 radiation exposure limits set forth for an uncontrolled environment. This equipment should be installed and operated with minimum distance 20cm between the radiator & your body.

Cet équipement est conforme aux limites d'exposition aux rayonnements IC établies pour un environnement non contrôlé. Cet équipement doit être installé et utilisé avec un minimum de 20cm de distance entre la source de rayonnement et votre corps.

## Customer Service

Thanks for choosing VIOFO!

From the date of purchase on, all products are warranted for 18 months and all accessories are warranted for 12 months. VIOFO offers lifetime technical support for all our users. We are committed to making sure that you are 100% satisfied with our products and services.

### Product Registration Program

VIOFO also have Product Registration Program to help customers extend warranty by 6 months. Visit [www.viofo.com](http://www.viofo.com) and register your new product to extend the warranty from 18 months to **24** months.









Scan the QR code to activate  
6-month extended warranty now

### Video Sharing

Share videos caught on VIOFO camera with us. Let's enjoy your new found together! Gain a chance to get a mysterious gift at [share@viofo.com](mailto:share@viofo.com).

### How to Contact Us ?

-  Submit a ticket at [support.viofo.com](http://support.viofo.com)
-  Live chat box at [www.viofo.com](http://www.viofo.com)
-  [support@viofo.com](mailto:support@viofo.com)
-  [www.facebook.com/viofo](http://www.facebook.com/viofo)
-  +86 755 8526 8909 (CN)
-  Mon-Fri 9am-6pm



Scan the QR code to submit a ticket