

V1.0

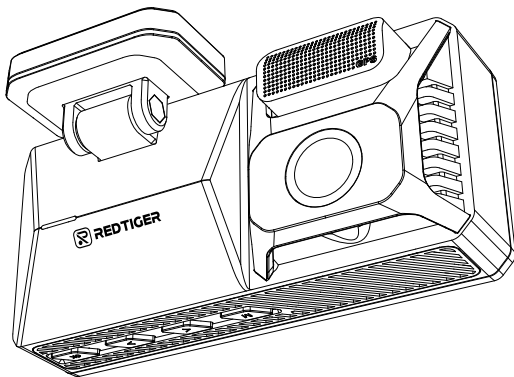

**REDTIGER**

Truly Peace of Mind



# **F77** User Manual

[redtigerscam.com](http://redtigerscam.com)

The information in this manual is subject to change without notice.

## General Overview

Notice . . . . .	I
Product Specifications . . . . .	II
Package Contents . . . . .	III
Appearance . . . . .	IV
Installation . . . . .	V
Troubleshooting . . . . .	VIII

## After-Sales

Customer Service Center . . . . .	86
-----------------------------------	----

## Language

English . . . . .	<b>1 - 17</b>
Deutsch . . . . .	<b>18 - 34</b>
Français . . . . .	<b>35 - 51</b>
Italiano . . . . .	<b>52 - 68</b>
Español . . . . .	<b>69 - 86</b>

## Notice

- Please read this manual carefully before operation and keep it for future reference. It will be helpful should you encounter any operational problems.
- Non-original parts or improper installation will void the manufacturer's warranty. The installation instructions do not apply to all types of vehicles and are written as guidelines to assist in installing the system.
- Consult with an experienced technician if you are not comfortable installing the device on your own.
- Please make sure to read and understand local laws and regulations regarding cameras and their use in a vehicle. Laws may vary by state.
- Do not obscure the view of the road ahead or obstruct the deployment of any airbags in the event of an accident.
- When not in use, please disconnect the car adapter from both the 12/24V DC outlet in your vehicle and the device itself.
- Only clean the device with a soft dry cloth, for tough dirt, apply some neutral detergent diluted in 5 to 6 parts water on a soft cloth.
- Note that alcohol, thinner, benzene, etc. could cause damage to the paint or coatings on the device.
- Avoid making contact with the lens as this may cause damage.
- The video recordings made by this device are intended for personal use only.
- While driving, do not adjust the controls of your device, as it may draw your attention from your surroundings.

## Product Specifications

Item Name	F77 Dash Cam	Video Format	MP4
Screen Size	4" IPS Screen	Photo Format	JPG
Recording Resolution	Front 4K@30fps+Rear 4K@30fps Front 2.5K@60fps+Rear 4K@30fps Front 2.5K@30fps+Rear 4K@30fps Front 4K@30fps / Front 2.5K@60fps / Front 2.5K@30fps		
Input	DC 5V-2.5A	Lens	Front cam F1.8 Rear cam F1.8
Operating Temperature	-4°F~158°F		
eMMC Storage	128GB	Warranty Period	18 months

### Note:

If you have any problems during use, we will provide free device replacement within 18 months of purchase, in addition to lifetime technical support.

### Extended Warranty Service:

You may also receive an additional 6 months of extended warranty service by registering your device on our website.

URL: <https://www.redtigercam.com/pages/warranty-form>

## Package Contents

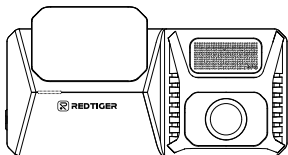

• F77 4K Dash Cam

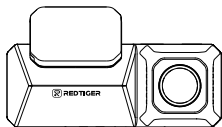

• 4K Rear Camera

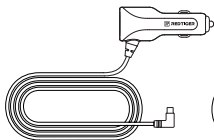

• Power Supply Cable with Car Charger



• Rear Cam Cable

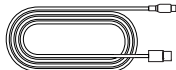

• USB Type-C Data Cable

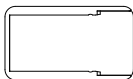

• Adhesive Slipcover



• Adhesive

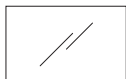

• Electrostatic Sticker



• User Manual



• Tool



• Cable Clips\*5

## Appearance

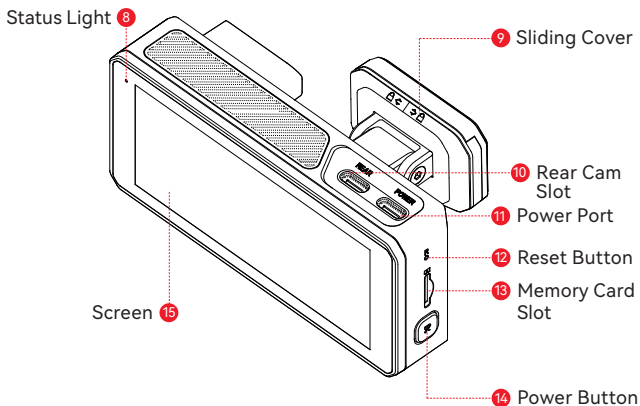
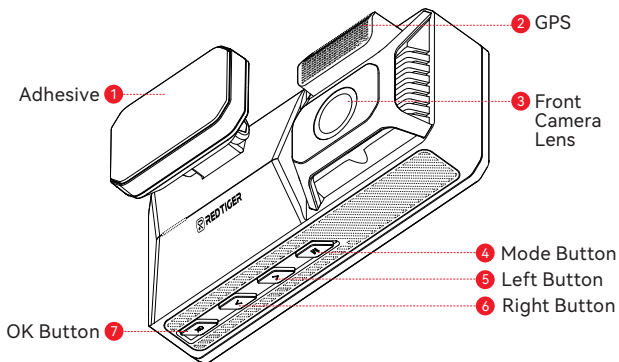

## Installation

- **Front camera installation**

Peel off the electrostatic sticker on the cellophane and transfer it to where you want to stick it. Attach the front camera to the electrostatic sticker and press to make it firmer.

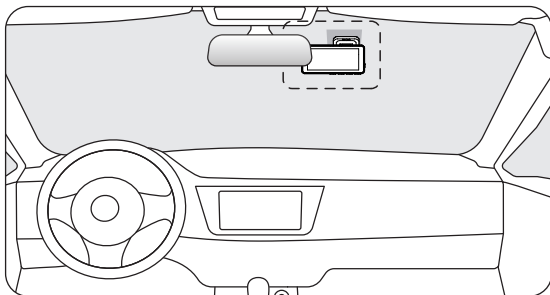
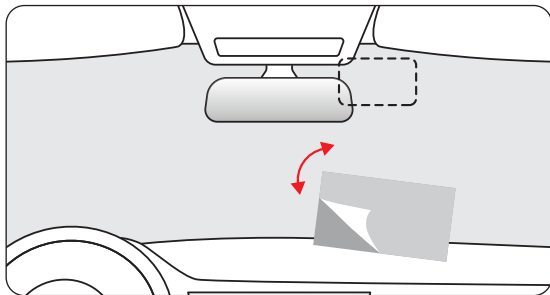

## • Wire Layout In The Vehicle

- 1 The car charger is connected to the cigar socket.
- 2 Connect the other end of the car charger to the dash cam.
- 3 Use the crowbar to run the power cable along the front windshield and the roof, and hide the cable down the A-pillar, so as not to block the driver's sight and cause danger.

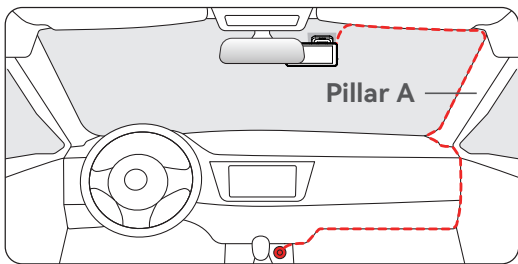

- 4 Connect the interface of the rear cable with the interface of the rear cam cable.
- 5 Hide the rear cam cable along the gaps between the front windshield and the ceiling, between the car body and the ceiling on the side of the passenger seat, and between the rear seats and the ceiling.

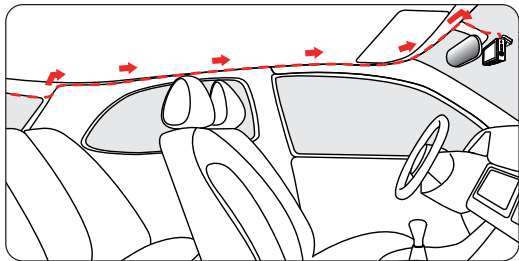

- **Rear camera installation**

Peel off the electrostatic sticker on the rear camera and transfer it to where you want to stick it. Attach the camera to the electrostatic sticker and press to make it firmer.

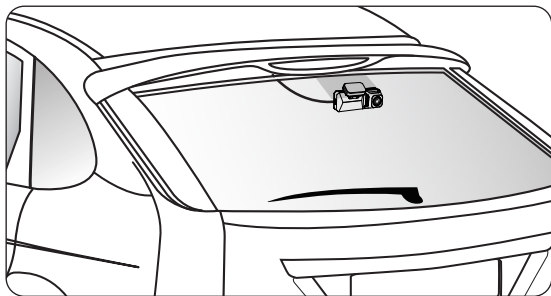
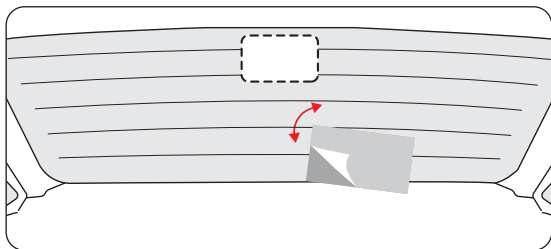

## Troubleshooting

- **Why is the machine running normally but there are no files in the memory card?**

The eMMC (Embedded Multi Media Card) is built into the dash cam for storage. The memory card does not automatically save files, but you can manually copy files to the memory card.

- **Why does my dash cam prompt “Card Error” or “Please Format Memory Card” occasionally?**

Please follow the steps below to check:

1. Please go to Settings > Format Reminder to check whether the regular format reminder is enabled.
2. Format the Memory Card.
3. Restore factory settings and restart the dash cam.
4. Update the firmware.

- **Device restarts repeatedly/no boot?**

1. Ensure you're using the included charger/cables.
2. Remove the memory card, camera cable, and car charger and reinstall them. Check if an issue was caused by the accessories.
3. Reset the device using the button at the bottom of the camera.
4. If the issue persists, connect the dash cam to a computer using a USB cable. If the device powers on, the issue may be caused by the car charger cable. If it does not power on while connected, there may be an issue with the dash cam itself.
5. Please go to the official website to update the firmware.
6. If it is not resolved, please contact our dedicated customer service for a replacement.

Buttons and Functions . . . . .	<b>2</b>
Touch Screen Function . . . . .	<b>4</b>
Voice Control Function . . . . .	<b>7</b>
User Interface Overview . . . . .	<b>8</b>
Function Overview . . . . .	<b>11</b>
Over-The-Air Updates . . . . .	<b>14</b>
How to Play Video on Computer . . . . .	<b>14</b>
Storage Settings . . . . .	<b>17</b>

## Buttons and Functions



### Power Button

Recording Mode:

- Short press-to Switch screen
- Long press-to Turn off the Camera

Setup Mode:

- Short press-to Turn on/off screen

Playback Mode:

- Short press-to Delete/Lock/Unlock the specific file



### Menu Button

Recording Mode:

- Short press to Enter main menu

Setup Mode:

- Short press-to Return to the previous screen

Playback Mode:

- Short press-to Return to the previous screen



### Left Button

Recording Mode:

- Short press-to Lock/Unlock the recording file
- Long press-to Turn on/off Wi-Fi

Setup Mode:

- Short press-to Select the previous function

Playback Mode:

- Short press-to Select the previous file
- Short press-to Fast rewind while video is being played



## **Right Button**

Recording Mode:

- Short press-to Turn on/off audio recording

Setup Mode:

- Short press-to Select the next function

Playback Mode:

- Short press-to Select the next file
- Short press-to Fast forward while video is being played

The text 'OK' in a bold, black, sans-serif font, centered within a light gray rounded square background.

## **OK Button**

Recording Mode:

- Short press-to Take a snapshot
- Long press-to Turn on/off video

Setup Mode:

- Short press-to Enter/Confirm specific settings

Playback Mode:

- Short press-to Play the specific file

## Touch Screen Function

- **Video Mode**

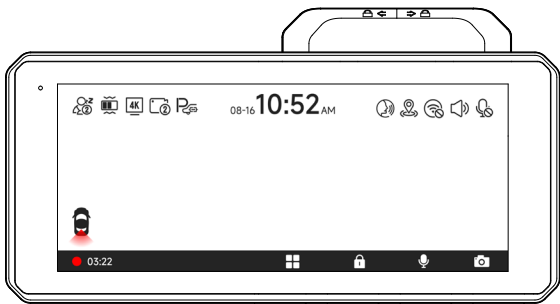

You can manually click the icon  at the top of the screen to choose whether to record audio during video recording.

You can manually click the icon  at the top of the screen to choose whether to turn on Wi-Fi.

You can manually click the icon  at the top of the screen to choose whether to turn on the key sound.

You can manually click the icon  at the top of the screen to choose whether to turn on the Voice control.

## • Playback Mode

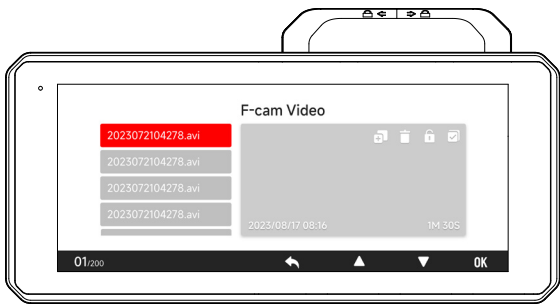

Swipe up and down on the playback interface to turn pages.

You can manually click the icon  to choose whether to copy the contents of the eMMC to the memory card.

You can manually click the icon  to choose whether to delete files.

You can manually click the icon  to choose whether to lock files.

You can manually click the icon  to choose whether to select multiple files.

## • Setting Mode

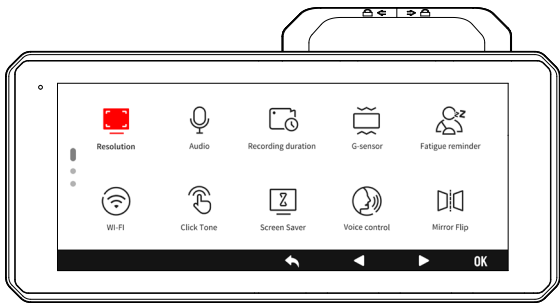

Swipe up and down on the setting interface to turn pages.

You can manually click the icon to enter the selected function interface.

## Voice Control Function

Fast control through simple voice commands

If the icon is white , it means the function can be used normally.

You have two ways to enable this feature.

- 1 Tap on the icon to turn the feature on or off.
- 2 Enter the setting mode-voice control-on/off.

lock the video	
take picture	
turn on audio	turn off audio
turn on screen	turn off screen
turn on wifi	turn off wifi
turn on recording	turn off recording
show front camera	show rear camera

### Note:







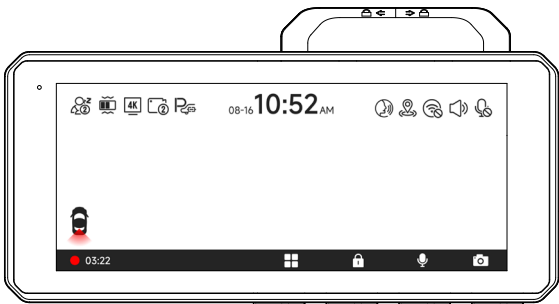





You can see the specific commands in setting-video control.

# User Interface Overview

- Recording Mode



Icon	Description
	Fatigue driving function is on
	G-Sensor sensitivity
	Front camera resolution
	Loop recording in 1 min/3 mins/5 mins per file
	Whether to connect the hardwired kit and set up parking monitoring
	Voice control

Icon	Description
	GPS status
	Wi-Fi status
	Camera system sound status
	Voice recording status
	Which camera is being displayed
	Recording status and recording time
	Emergency recording is on
	Date and time of the camera
	Settings
	Emergency recording
	Turn on or off recording
	Photograph

## • Playback Mode

- 1 Press the **M** button to enter Playback mode.
- 2 Press the Left or Right button to select the folder you want to play, then press the **OK** button to enter.

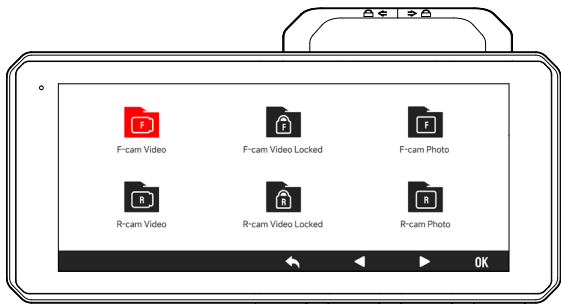



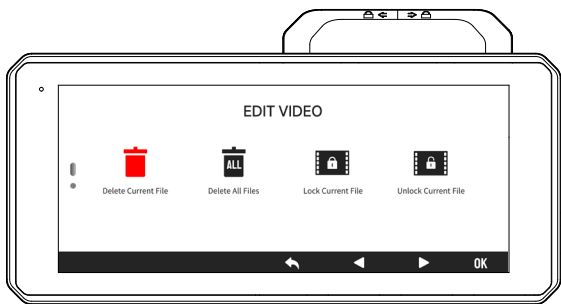



















- 3 Press the **OK** button to watch the recorded video.
- 4 Short press the power button to edit your recorded videos.











## Function Overview

Short press M button to enter settings menu, where you can adjust various functions and parameters of the entire machine.

Icon	Function	Option/Description
	Resolution	Front 4K@30fps+Rear 4K@30fps / Front 2.5K@60fps+Rear 4K@30fps/ Front 2.5K@30fps+Rear 4K@30fps/ Front 4K@30fps/Front 2.5K@60fps/ Front 2.5K@30fps
	Audio	ON/OFF
	Recording Duration	1/3/5mins
	G-sensor	Off/Low/Medium/High
	Fatigue Reminder	A Reminder Will be Made During 1h/2h/3h/OFF
	Wi-Fi	OFF/2.4GHz/5.8GHz
	Click Tone	ON/OFF
	Screen Saver	OFF/10s/30s/2mins, Screen goes off after the set time
	Voice Control	ON/OFF/Voice Command
	Mirror Flip	Horizontal Flip Your Rear View *Need to connect rear camera

Icon	Function	Option/Description
	Rear Cam Flip	Vertical Flip Your Rear View *Need to connect rear camera
	Parking Monitor	Please connect the ACC hardwire kit
	GPS	Display GPS signal strength
	TimeWatermark	ON/OFF
	Speed Stamp	ON/OFF
	GPS Stamp	ON/OFF
	Speed Units	KM/H / MPH
	Language	Choose Your Preferred Language
	Clock Settings	Update With GPS
	Time Format	12h/24h
	Time Zone	Choose Your Time Zone
	DST	Daylight Saving Time ON/OFF

Icon	Function	Option/Description
	Flicker	60Hz/50Hz
	Format Reminder	Reminder to Clear Data
	Format	Format eMMC or memory card.All data will be deleted
	Card Speed	Card Speed Detection
	Default Setting	Reset All Settings
	APP	A QR Code for redtiger app
	Version	Software Version
	Help Center	Scan the QR code to contact us

## Note:

- In order to a Clean, Smooth, Comfortable using experience, we suggest you format your eMMC storage once a month.
- When you turn off Click Tone, the start up and shut down sounds will also be turned off.

## Over-The-Air Updates

**Note:** Please update the Redtiger Cam App to the latest version to use this function.

1. To perform an over-the-air update, disconnect your phone from the dash cam's Wi-Fi network. Connect your phone to LAN (not the dash cam's Wi-Fi) for 5 seconds, then disconnect. Reconnect to the dash cam's Wi-Fi network.
2. Once Wi-Fi connection is successful, open the Redtiger Cam App to start using it. If new software is detected, the App page will indicate the availability of an update.
3. To perform the update, click on "Upgrade Now". The Redtiger Cam App will prompt you to download the update package.
4. Connect the dash cam to send the update package. Do not power off the dash cam during the upgrade process. Once the upgrade is completed, the app will display the upgrade success message, and the dash cam will automatically restart.

## How to Play Video on Computer

We recommend using REDTIGER Player as the correct video player to watch/play videos. It can also view Google Maps.

You can Download it for free on Mac or Windows from the following link: <https://www.redtigerscam.com/pages/gps-player>

You can choose different playback modes in Settings > Video Playback Mode. You can set playback speed, language, map, and various other functions.

## TIPS:

Data can be output from the main unit to a personal computer using a USB cable. Alternatively, you can insert a memory card into the dash cam and copy data from the eMMC, transfer data by using a card reader.

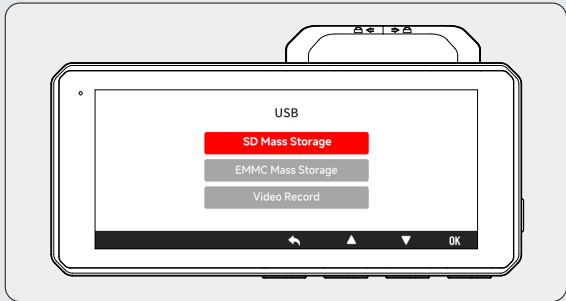
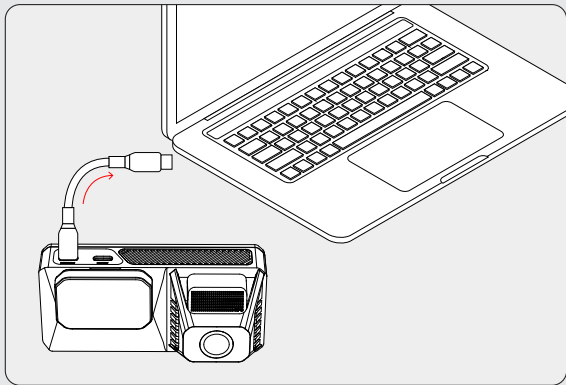

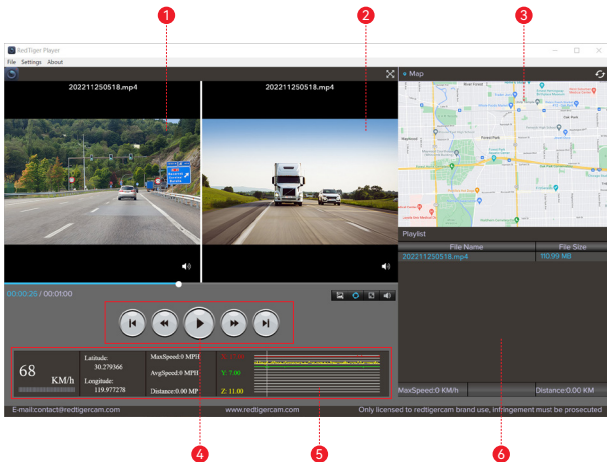

- ① Video play window (Front)
- ② Video play window (Rear)
- ③ Map and track display
- ④ Play control panel
- ⑤ Speed and driving state indication
- ⑥ Play list

### Note:

If the video files of front and rear road tracks are recorded synchronously and loaded into the playing list at the same time, they can be played separately in split left and right screens.

When you find the desired video file, hold down the left mouse button and drag the desired files to the video play window to play it.

## Storage Settings

### **⚠ WARNING**

Please make sure to connect all cameras and wires before powering on the camera screen, otherwise the camera will not work properly. Please follow the instructions below for the first-time installation of the Redtiger dash cam.

### **• eMMC Storage**

The dash cam comes with built-in 128 GB eMMC (Embedded Multi Media Card) storage, eliminating the need for additional purchase and installation of a memory card, allowing for immediate recording upon startup.

### **• Insert Memory Card (Optional Operation)**

F77 also support using memory cards to copy the videos you need. You can do this in the playback folder by clicking "Copy Current" or "Copy Selected."

Tips: Video is not saved directly to the memory card. Insert the memory card into the dash cam, ensuring that it is oriented correctly so that the gold contacts are facing towards the screen of the dash cam. Push the memory card until it clicks into the slot.

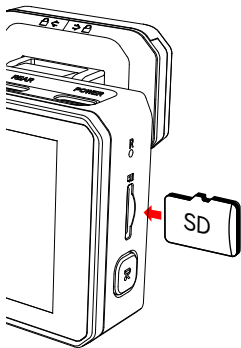

Tasten und Funktionen . . . . .	<b>19</b>
Touchscreen-Funktion. . . . .	<b>21</b>
Sprachsteuerungsfunktion . . . . .	<b>24</b>
Übersicht über die Benutzeroberfläche . . . . .	<b>25</b>
Funktionsübersicht . . . . .	<b>28</b>
OTA(Over the air) Update . . . . .	<b>31</b>
Wie man Video Auf dem Computer Abspielt . . . . .	<b>31</b>
Speichereinstellungen . . . . .	<b>34</b>

## Tasten und Funktionen



### Power-Taste

Aufnahmemodus:

- Kurz drücken, um den Bildschirm zu wechseln
- Lange drücken, um die Kamera auszuschalten

Setup-Modus:

- Kurzer Druck - Bildschirm ein-/ausschalten

Wiedergabemodus:

- Kurzer Druck - Datei löschen/sperrern/entsperren



### Menü-Taste

Aufnahmemodus:

- Kurz drücken, um das Hauptmenü aufzurufen

Setup-Modus:

- Kurzer Druck - Zurück zum vorherigen Bildschirm

Wiedergabemodus:

- Kurzer Druck - Zurück zum vorherigen Bildschirm



### Linke Taste

Recording Mode:

- Kurzer Druck - Aufnahme sperren/entsperren
- Langer Druck - Wi-Fi ein-/ausschalten

Setup Mode:

- Short press-to Select the previous function

Playback Mode:

- Kurzer Druck - Schnell zurückspulen, während das Video abgespielt wird



## **Rechte Taste**

Aufnahmemodus:

- Kurzer Druck - Audioaufnahme ein-/ausschalten

Setup-Modus:

- Kurz drücken, um die nächste Funktion auszuwählen

Wiedergabemodus:

- Kurz drücken, um die nächste Datei auszuwählen
- Kurz drücken, um schnell vorzuspulen (während das Video abgespielt wird)

## **OK-Taste**

Aufnahmemodus:

- Kurzer Druck - Ein Foto aufnehmen
- Langer Druck - Video ein-/ausschalten

Einrichtungsmodus:

- Kurzer Druck - Bestimmte Einstellungen eingeben/ bestätigen

Wiedergabemodus:

- Kurzer Druck - Die spezifische Datei abspielen

# Touchscreen-Funktion

- Videomodus

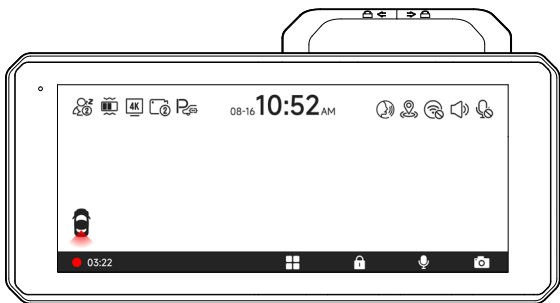

Sie können manuell auf das Symbol  oben auf dem Bildschirm klicken, um auszuwählen, ob Audio während der Videoaufnahme aufgenommen werden soll.

Sie können manuell auf das Symbol  oben auf dem Bildschirm klicken, um auszuwählen, ob WLAN aktiviert werden soll.

Sie können manuell auf das Symbol  oben auf dem Bildschirm klicken, um auszuwählen, ob Sie den Tastaturton einschalten möchten.

Sie können manuell auf das Symbol  oben auf dem Bildschirm klicken, um auszuwählen, ob Sie die Sprachsteuerung aktivieren möchten.

## • Wiedergabemodus

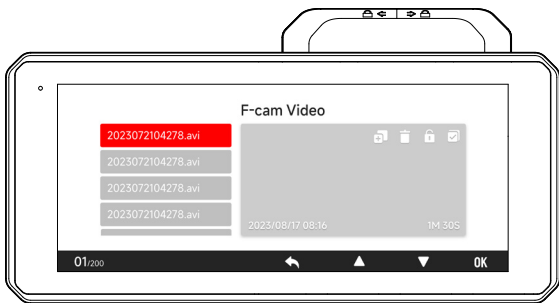

Wischen Sie auf der Wiedergabeoberfläche nach oben und unten, um die Seiten umzublättern.

Sie können manuell auf das Symbol  klicken, um auszuwählen, ob der Inhalt des eMMC auf die Speicherkarte kopiert werden soll.

Sie können manuell auf das Symbol  klicken, um auszuwählen, ob Dateien gelöscht werden sollen.

Sie können manuell auf das Symbol  klicken, um auszuwählen, ob Dateien gesperrt werden sollen.

Sie können manuell auf das Symbol  klicken, um auszuwählen, ob mehrere Dateien ausgewählt werden sollen.

## • Einstellungsmodus

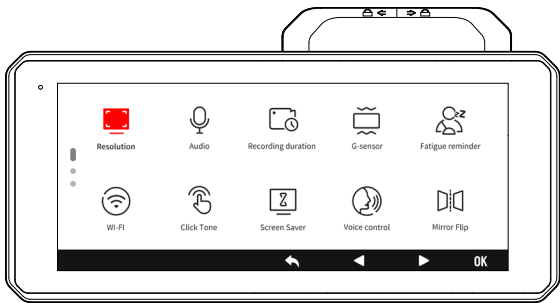

Wischen Sie auf der Einstellungsoberfläche nach oben und unten, um die Seiten umzublättern.

Sie können manuell auf das Symbol klicken, um die ausgewählte Funktionsoberfläche zu öffnen.

## Sprachsteuerungsfunktion

Schnelle Steuerung durch einfache Sprachbefehle.

Wenn das Symbol  weiß ist, bedeutet dies, dass die Funktion normal verwendet werden kann.

Es gibt zwei Möglichkeiten, diese Funktion zu aktivieren.

- 1 Tippen Sie auf das Symbol, um die Funktion zu aktivieren oder zu deaktivieren.
- 2 Gehen Sie zu Einstellungen – Sprachsteuerung – Ein/Aus.

lock the video	
take picture	
turn on Audio	turn off Audio
turn on screen	turn off screen
turn on wifi	turn off wifi
turn on recording	turn off recording
show front camera	show rear camera

### Hinweis:







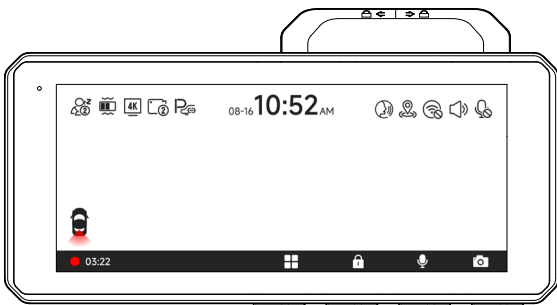

1. Sie können spezifische Befehle in den Einstellungen für Sprachsteuerung sehen.
2. Die Sprachsteuerungsfunktion unterstützt nur Englisch.

# Übersicht über die Benutzeroberfläche

## • Aufnahmemodus



Symbol	Beschreibung
	Die Müdigkeitserkennungsfunktion ist aktiviert
	G-Sensor-Empfindlichkeit
	Frontkamera-Auflösung
	Schleifenaufzeichnung in 1 Min/3 Min/5 Min pro Datei
	Ob das Festverdrahtungsset angeschlossen und die Parküberwachung eingerichtet werden soll
	Sprachsteuerung

Symbol	Beschreibung
	GPS-Status
	Wi-Fi-Status
	Kamerasystem-Soundstatus
	Sprachauszeichnungsstatus
	Welche Kamera angezeigt wird
● 03:22	Aufnahmestatus und Aufnahmezeit
● 03:22	Notfallaufnahme ist aktiviert
08-16 10:52 AM	Datum und Uhrzeit der Kamera
	Einstellungen
	Notfallaufnahme
	Aufnahme ein- oder ausschalten
	Fotografieren

## • Wiedergabemodus

- 1 Drücken Sie die **M** Taste, um in den Wiedergabemodus zu gelangen.
- 2 Drücken Sie die linke oder rechte Taste, um den Ordner auszuwählen, den Sie abspielen möchten, und drücken Sie dann die **OK** Taste, um einzutreten.

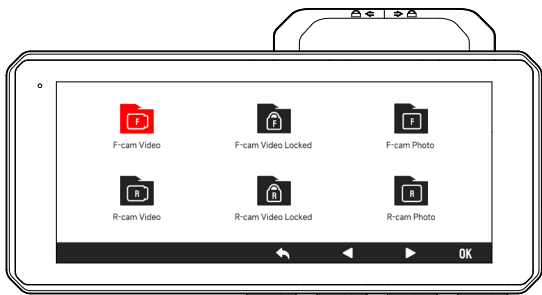



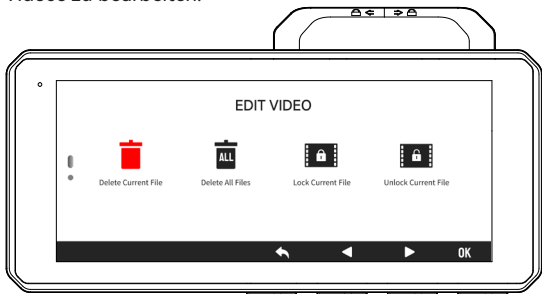









- 3 Drücken Sie die **OK** Taste, um das aufgezeichnete Video anzusehen.
- 4 Drücken Sie kurz die Einschalttaste, um Ihre aufgenommenen Videos zu bearbeiten.



## Funktionsübersicht

Drücken Sie kurz die M-Taste, um das Einstellungs Menü aufzurufen, in dem Sie verschiedene Funktionen und Parameter der Kamera anpassen können.

Symbol	Funktion	Option/Beschreibung
	Auflösung	Vorne 4K@30fps + Hinten 4K@30fps Vorne 2.5K@60fps + Hinten 4K@30fps Vorne 2.5K@30fps + Hinten 4K@30fps Vorne 4K@30fps / Vorne 2.5K@60fps Vorne 2.5K@30fps
	Audio	EIN/AUS
	Aufnahmedauer	1/3/5 Minuten
	G-Sensor	Aus / Niedrig / Mittel / Hoch
	Müdigkeitswarnung	1h / 2h / 3h / 4h / AUS
	Wi-Fi	AUS / 2.4GHz / 5.8GHz
	Klick-Ton	EIN/AUS
	Bildschirmschoner	AUS / 10s / 30s / 2min, Bildschirm geht nach der eingestellten Zeit aus
	Sprachsteuerung	EIN/AUS / Sprachbefehl
	Bildspiegelung	Horizontale Spiegelung der Rückansicht * Rückfahrkamera muss angeschlossen werden

Symbol	Funktion	Option/Beschreibung
	Rückfahrkamera Spiegelung	Vertikal Spiegelung der Rückansicht * Rückfahrkamera muss angeschlossen werden
	Parküberwachung	Bitte schließen Sie das ACC Hardwire Kit an
	GPS	GPS-Signalstärke anzeigen
	Datumsstempel	EIN/AUS
	Geschwindigkeitsstempel	EIN/AUS
	GPS-Stempel	EIN/AUS
	Geschwindigkeits-Einheiten	KM/H / MPH
	Sprache	Wählen Sie Ihre bevorzugte Sprache
	Uhreinstellungen	Update mit GPS
	Zeitformat	12h/24h
	Zeitzone	Wählen Sie Ihre Zeitzone
	Sommerzeit	Sommerzeit EIN/AUS

Symbol	Funktion	Option/Beschreibung
	Frequenz	60Hz/50Hz
	Format-Erinnerung	Erinnerung zum Löschen von Daten
	Format	eMMC oder Speicherkarte formatieren. Alle Daten werden gelöscht.
	Kartengeschwindigkeit	Kartengeschwindigkeits-Erkennung
	Standard-Einstellung	Alle Einstellungen zurücksetzen
	APP	QR-Code für Redtiger App
	Version	Softwareversion
	Hilfe-Center	Scannen Sie den QR-Code für Kontakt

## Hinweis :

- Um ein reibungsloses Benutzererlebnis zu gewährleisten, wird empfohlen, dass Sie Ihre Speicherkarte einmal im Monat formatieren.
- Wenn Sie die Einstellung Klick-Ton auf AUS ändern, werden auch die Töne beim Einschalten und Ausschalten ausgeschaltet.

## OTA(Over the air) Update

**Hinweis:** Bitte aktualisieren Sie die Redtiger Cam App auf die neueste Version, um diese Funktion nutzen zu können.

1. Um ein Over-the-Air-Update durchzuführen, trennen Sie Ihr Telefon vom Wi-Fi-Netzwerk der Dashcam. Verbinden Sie Ihr Telefon 5 Sekunden lang mit dem LAN (nicht mit dem Wi-Fi der Dashcam), dann trennen Sie die Verbindung. Stellen Sie erneut eine Verbindung zum Wi-Fi-Netzwerk der Dashcam her.
2. Sobald die Wi-Fi-Verbindung erfolgreich ist, öffnen Sie die Redtiger-Cam-App, um sie zu verwenden. Wenn neue Software erkannt wird, zeigt die App-Seite die Verfügbarkeit eines Updates an.
3. Um das Update durchzuführen, klicken Sie auf „Jetzt aktualisieren“. Die Redtiger Cam App wird Sie auffordern, das Update-Paket herunterzuladen.
4. Schließen Sie die Dashcam an, um das Update-Paket zu senden. Schalten Sie die Dashcam während des Upgrade-Vorgangs nicht aus. Sobald das Upgrade abgeschlossen ist, zeigt die App die Erfolgsmeldung des Upgrades an, und die Dashcam wird automatisch neu gestartet.

## Wie man Video Auf dem Computer Abspielt

Wir empfehlen die Verwendung des REDTIGER Players als den richtigen Videoplayer zum Ansehen/Abspielen von Videos. Er kann auch Google Maps anzeigen.

Sie können ihn kostenlos auf Mac oder Windows über den folgenden Link herunterladen: <https://www.redtigerscam.com/pages/gps-player>

Sie können unter Einstellungen > Videowiedergabemodus verschiedene Wiedergabemodi auswählen. Sie können Wiedergabegeschwindigkeit, Sprache, Karte und verschiedene andere Funktionen einstellen.

## TIPPS:

Die Daten können über ein USB-Kabel vom Hauptgerät auf einen Computer übertragen werden. Alternativ können Sie eine Speicherkarte in die Dashcam einlegen und die Daten von der eMMC kopieren oder mit einem Kartenleser übertragen.

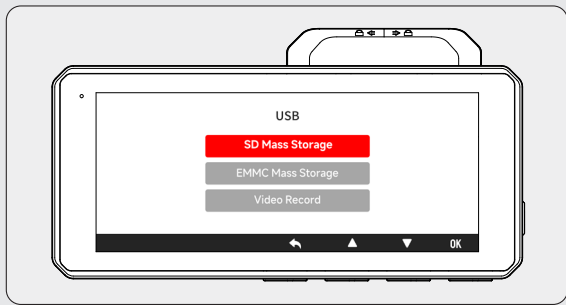
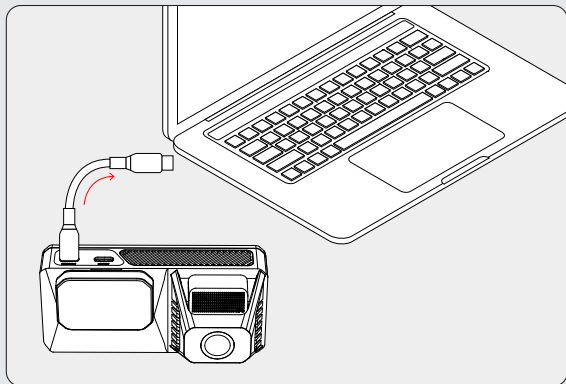

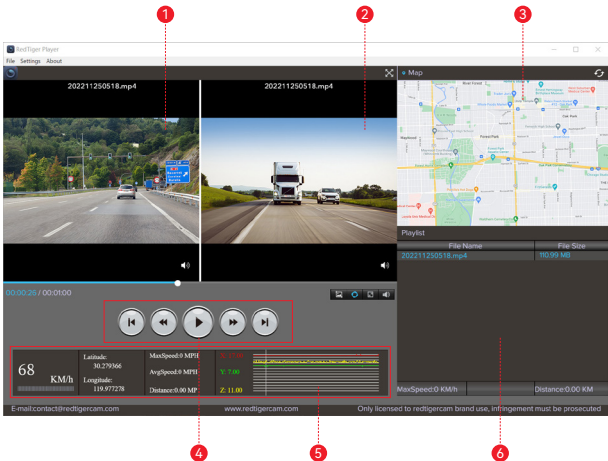

- 1 Fenster zur Videowiedergabe (Vorderseite)
- 2 Video-Wiedergabefenster (Rückseite)
- 3 Karten- und Spuranzeige
- 4 Wiedergabe-Bedienfeld
- 5 Geschwindigkeits- und Fahrzustandsanzeige
- 6 Wiedergabeliste

### Hinweis:

Wenn die Videodateien der vorderen und hinteren Straßenspuren synchron aufgezeichnet und gleichzeitig in die Wiedergabeliste geladen werden, können sie separat auf geteilten linken und rechten Bildschirmen abgespielt werden.

Wenn Sie die gewünschte Videodatei gefunden haben, halten Sie die linke Maustaste gedrückt und ziehen Sie die gewünschten Dateien in das Videowiedergabefenster, um sie abzuspielen.

# Speichereinstellungen

## **⚠ WARNING**

Bitte stellen Sie sicher, dass alle Kameras und Kabel angeschlossen sind, bevor Sie den Kamerabildschirm einschalten, andernfalls wird die Kamera nicht richtig funktionieren. Bitte befolgen Sie die nachstehenden Anweisungen für die Erstinstallation der Redtiger Dashcam.

### **• eMMC-Speicher**

Die Dashcam verfügt über einen integrierten 128 GB eMMCSpeicher (Embedded Multi Media Card), der den Kauf und die Installation einer zusätzlichen Speicherkarte überflüssig macht und eine sofortige Aufzeichnung beim Start ermöglicht.

### **• Einlegen der Speicherkarte (optionaler Vorgang)**

Der F77 unterstützt auch die Verwendung von Speicherkarten, um die benötigten Videos zu kopieren. Sie können dies im Wiedergabeordner tun, indem Sie auf „Aktuelle kopieren“ oder „Ausgewählte kopieren“ klicken.

Tipps: Videos werden nicht direkt auf der Speicherkarte gespeichert. Setzen Sie die Speicherkarte in die Dashcam ein und achten Sie darauf, dass sie richtig ausgerichtet ist, so dass die goldenen Kontakte zum Bildschirm der Dashcam zeigen. Drücken Sie die Speicherkarte in den Steckplatz, bis sie einrastet.

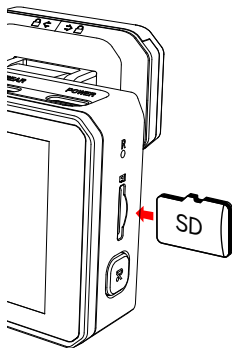

Boutons et Fonctions . . . . .	<b>36</b>
Fonction écran Tactile . . . . .	<b>38</b>
Fonction de Contrôle Vocal . . . . .	<b>41</b>
Aperçu de l'interface d'utilisateur . . . . .	<b>42</b>
Aperçu des Fonctionnalités . . . . .	<b>45</b>
Mise à Jour OTA (Sans Fil). . . . .	<b>48</b>
Comment Regarder une Vidéo Sur un Ordinateur . . . . .	<b>48</b>
Paramètres de stockage. . . . .	<b>51</b>

## Boutons et Fonctions



### Bouton d'alimentation

Mode d'enregistrement:

- Appuyez brièvement pour changer d'écran
- Appuyez longuement pour éteindre la caméra

Mode d'installation:

- Appui court - Allumer/éteindre l'écran

Mode de lecture:

- Appui court - Supprimer/verrouiller/déverrouiller le fichier spécifique



### Bouton de menu

Mode d'enregistrement:

- Appuyez brièvement pour accéder au menu principal

Mode d'installation:

- Appui court - Retourner à l'écran précédent

Mode de lecture:

- Appui court - Retourner à l'écran précédent



### Bouton gauche

Mode d'enregistrement:

- Appui court - Verrouiller/déverrouiller le fichier d'enregistrement
- Appui long - Activer/désactiver le Wi-Fi

Mode d'installation:

- Appuyez brièvement pour sélectionner la fonction précédente

Mode de lecture:

- Appui court - Rembobiner rapidement pendant la lecture de la vidéo



## **Bouton droit**

Mode d'enregistrement:

- Appui court - Activer/désactiver l'enregistrement audio

Mode d'installation:

- Appuyez brièvement pour sélectionner la fonction suivante

Mode de lecture:

- Appuyez brièvement pour sélectionner le fichier suivant
- Appuyez brièvement pour Avance rapide (lors de la lecture d'une vidéo)

## **Bouton OK**

Mode d'enregistrement :

- Appui court - Prendre une photo
- Appui long - Activer/désactiver la vidéo

Mode de configuration :

- Appui court - Entrer/confirmer des réglages spécifiques

Mode de lecture :

- Appui court - Lire le fichier spécifique

## Fonction écran Tactile

- Mode vidéo

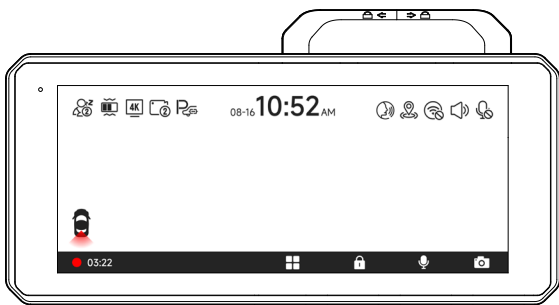

Vous pouvez cliquer manuellement sur le symbole  en haut de l'écran pour choisir si l'audio doit être enregistré pendant l'enregistrement vidéo.

Vous pouvez cliquer manuellement sur le symbole  en haut de l'écran pour choisir si le WLAN doit être activé.

Vous pouvez cliquer manuellement sur le symbole  en haut de l'écran pour choisir si vous souhaitez activer le son de la touche.

Vous pouvez cliquer manuellement sur le symbole  en haut de l'écran pour choisir si vous souhaitez activer le contrôle vocal.

## • Mode de lecture

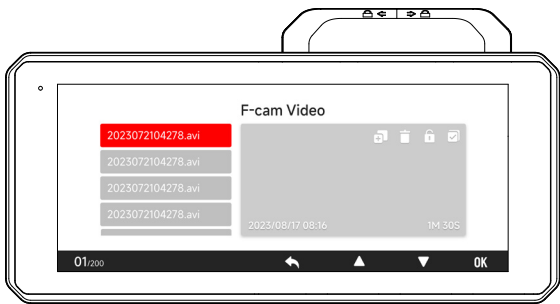

Faites glisser vers le haut et vers le bas sur l'interface de lecture pour tourner les pages.

Vous pouvez cliquer manuellement sur l'icône  pour choisir si vous souhaitez copier le contenu de l'eMMC sur la carte mémoire.

Vous pouvez cliquer manuellement sur l'icône  pour choisir si vous souhaitez supprimer des fichiers.

Vous pouvez cliquer manuellement sur l'icône  pour choisir si vous souhaitez verrouiller des fichiers.

Vous pouvez cliquer manuellement sur l'icône  pour choisir si vous souhaitez sélectionner plusieurs fichiers.

## • Mode de configuration

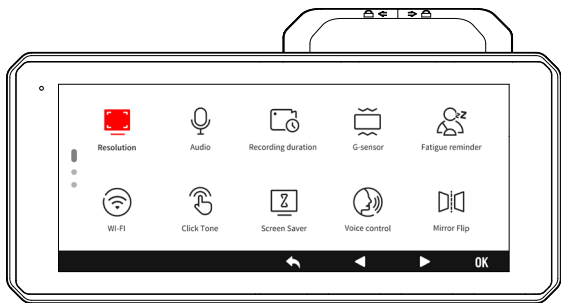

Faites glisser vers le haut et vers le bas sur l'interface des paramètres pour tourner les pages.

Vous pouvez cliquer manuellement sur l'icône pour entrer dans l'interface de la fonction sélectionnée.

## Fonction de Contrôle Vocal

Contrôle rapide via commandes vocales simples.

Quand le symbole  est blanc, cela signifie que la fonction peut être utilisée normalement.

Il y a deux façons d'activer cette fonction.

- 1 Appuyez sur le symbole pour activer ou désactiver la fonction.
- 2 Accédez à Paramètres - Contrôle vocal - Activer/Désactiver.

lock the video	
take picture	
turn on Audio	turn off Audio
turn on screen	turn off screen
turn on wifi	turn off wifi
turn on recording	turn off recording
show front camera	show rear camera

### Note:







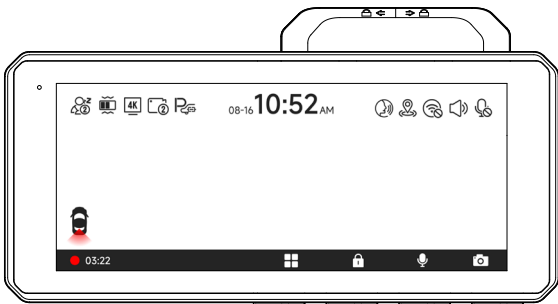





1. Vous pouvez voir des commandes spécifiques dans les paramètres de contrôle vocal.
2. La fonction de contrôle vocal ne supporte que l'anglais.

# Aperçu de l'interface d'utilisateur

## • Mode d'enregistrement



Icône	Description
	La fonction de détection de fatigue est activée
	Sensibilité du capteur G
	Résolution de la caméra avant
	Enregistrement en boucle de 1 min/3 min/5 min par fichier
	Si connecter le kit câblé et configurer la surveillance de stationnement
	Contrôle vocal

Icône	Description
	Statut du GPS
	Statut du Wi-Fi
	Statut du son du système de caméra
	Statut de l'enregistrement vocal
	Quelle caméra est affichée
	Statut et durée de l'enregistrement
	L'enregistrement d'urgence est activé
	Date et heure de la caméra
	Paramètres
	Enregistrement d'urgence
	Activer ou désactiver l'enregistrement
	Photographier

## • Mode de lecture

- 1 Appuyez sur le bouton **M** pour entrer en mode de lecture.
- 2 Appuyez sur le bouton gauche ou droit pour sélectionner le dossier que vous souhaitez lire, puis appuyez sur le bouton **OK** pour entrer.

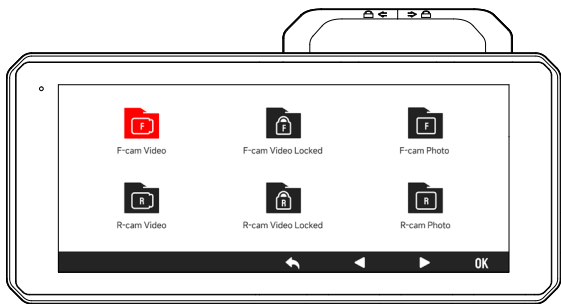



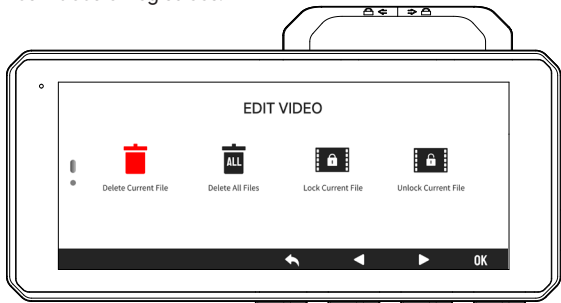









- 3 Appuyez sur le bouton **OK** pour regarder la vidéo enregistrée.
- 4 Appuyez brièvement sur le bouton d'alimentation pour éditer vos vidéos enregistrées.









## Aperçu des Fonctionnalités

Appuyez brièvement sur le bouton M pour accéder au menu de l'installation, vous pouvez régler diverses fonctions et paramètres de la caméra.

Icône	Fonction	Sélection/Description
	Résolution	Avant 4K@30fps + Arrière 4K@30fps Avant 2.5K@60fps + Arrière 4K@30fps Avant 2.5K@30fps + Arrière 4K@30fps Avant 4K@30fps / Avant 2.5K@60fps Avant 2.5K@30fps
	Enregistrement Audio	Activé/Désactivé
	Temps d'enregistrement	1/3/5 Minutes
	G-Sensor	Désactivé / Faible / Moyen / Élevé
	Avertissement de Fatigue	1h / 2h / 3h / 4h / Désactivé
	Wi-Fi	ÉTEINT / 2.4GHz / 5.8GHz
	Cliquez Sur Le Son	Activé/Désactivé
	Screensaver	Désactivé / 10s / 30s / 2min, l'écran s'éteint après le temps défini
	Commande Vocale	Activé/Désactivé / Commande Vocale
	Image Miroir	Retournement horizontal de l'image de la caméra de recul * Une caméra de recul doit être connectée

Icône	Fonction	Sélection/Description
	Inversion Verticale de l'image	Rétroiseur: Retournement vertical de l'image de la caméra de recul * Une caméra de recul doit être connectée
	Surveillance du Stationnement	Veuillez connecter le kit de câblage ACC
	GPS	Montrer la force du signal GPS
	Horodatage	Activé/Désactivé
	Vitesse Watermark	Activé/Désactivé
	GPS Watermark	Activé/Désactivé
	Unité de vitesse	KM/H/MPH
	Langue	Choisissez votre langue préférée
	Réglage de l'horloge	Mise à jour avec GPS
	Format Horaire	12h/24h
	Fuseau Horaire	Choisissez votre fuseau horaire
	Heure d'été	Activé/Désactivé

Icône	Fonction	Sélection/Description
	Fréquence d'affichage	60Hz/50Hz
	Rappel de Formatage	Rappel de suppression de données
	Formater la Carte SD	Formater l'eMMC ou la carte mémoire. Toutes les données seront supprimées
	Test de Vitesse de Carte	Détection de vitesse de carte
	Paramètres par Défaut	Réinitialiser à les paramètres d'origine
	APP	QR code pour l'application RedTiger
	Numéro de Version	Version du software
	Centre d'aide	Scanner le QR code pour contact

## Note:

- Pour garantir une expérience utilisateur fluide, il est recommandé de formater votre carte mémoire une fois par mois.
- Si vous désactivez le paramètre "Son de clique", les sons d'activation et de désactivation seront également supprimés.

## Mise à Jour OTA (Sans Fil)

**Note:** Veuillez mettre à jour l'app Redtiger vers la dernière version pour utiliser cette fonctionnalité.

1. Pour effectuer la mise à jour en direct, déconnectez votre téléphone du réseau Wi-Fi de votre tachygraphe. Connectez votre téléphone à un réseau local (pas au Wi-Fi de votre tachygraphe) pendant 5 secondes, puis déconnectez-vous. Reconnectez le réseau Wi-Fi du tachygraphe.
2. Une fois la connexion Wi-Fi établie, ouvrez l'app Redtiger et commencez à l'utiliser. Si un nouveau logiciel est détecté, la page de l'app affichera la disponibilité de la mise à jour.
3. Pour effectuer la mise à jour, cliquez sur Mettre à jour maintenant. L'application Redtiger vous demandera de télécharger le package de mise à jour.
4. Connectez le tachygraphe pour envoyer un package de mise à jour. N'éteignez pas le tachygraphe pendant le processus de mise à jour. Une fois la mise à jour terminée, l'app affichera le message de réussite de la mise à jour et le tachygraphe redémarrera automatiquement.

## Comment Regarder une Vidéo Sur un Ordinateur

Nous vous recommandons d'utiliser Lecteur REDTIGER comme lecteur vidéo approprié pour regarder/lire des vidéos. Il peut également afficher Carte Google.

Vous pouvez le télécharger gratuitement sur Mac ou Windows à partir du lien suivant: <https://www.redtigercam.com/pages/gps-player>

pouvez choisir différentes méthodes de lecture d'enregistrement dans Paramètres > Mode de lecture vidéo. Vous pouvez définir la vitesse de lecture, la langue, la carte et plus encore.

## CONSEILS :

Les données peuvent être transférées de l'unité principale vers un ordinateur personnel à l'aide d'un câble USB. Vous pouvez également insérer une carte mémoire dans le dash cam et copier les données de l'eMMC, transférer les données à l'aide d'un lecteur de carte.

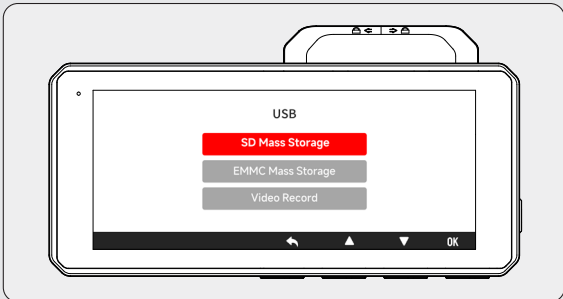
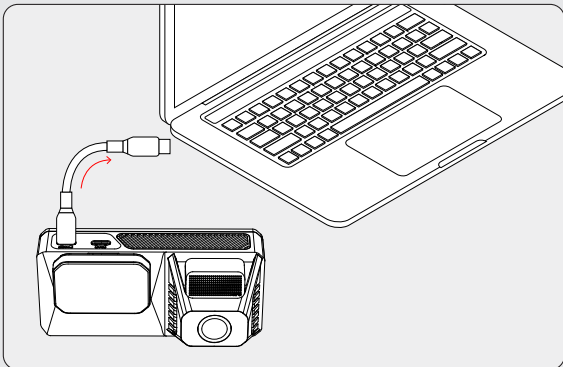

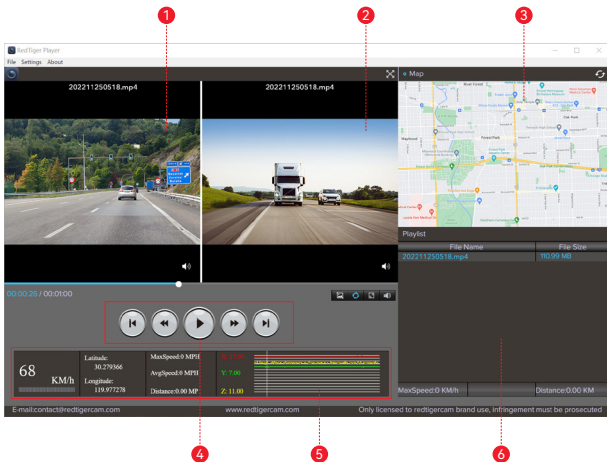

- 1 Fenêtre de lecture vidéo (avant)
- 2 Fenêtre de lecture vidéo (arrière)
- 3 Affichage de la carte et de la piste
- 4 Panneau de configuration de lecture
- 5 Indications de vitesse et d'état de conduite
- 6 Liste de lecture

### Note:

Si vous enregistrez des vidéos de tachygraphe avant et arrière en même temps et que vous les ajoutez à la liste de lecture, elles peuvent être lues séparément sur les écrans gauche et droit. Lorsque vous trouvez un fichier vidéo que vous souhaitez lire, maintenez le bouton gauche de la souris enfoncé et faites glisser et déposez le fichier vidéo que vous souhaitez lire dans la fenêtre de lecture vidéo.

## Paramètres de stockage

### **⚠ AVERTISSEMENT**

Assurez-vous de connecter toutes les caméras et tous les fils avant d'allumer l'écran de caméra, sinon la caméra ne fonctionnera pas correctement. Suivez les instructions ci-dessous pour installer votre tachygraphe de Redtiger pour la première fois.

### • **Stockage eMMC**

La dashcam est équipée d'un stockage eMMC (Embedded Multi Media Card) intégré de 128 Go, ce qui élimine le besoin d'acheter et d'installer une carte mémoire supplémentaire et permet un enregistrement immédiat dès le démarrage.

### • **Insertion d'une carte mémoire (opération facultative)**

La F77 permet également d'utiliser des cartes mémoire pour copier les vidéos dont vous avez besoin. Vous pouvez le faire dans le dossier de lecture en cliquant sur « Copier actuel » ou « Copier sélectionné ».

Conseils : La vidéo n'est pas sauvegardée directement sur la carte mémoire. Insérez la carte mémoire dans la dash cam, en veillant à ce qu'elle soit orientée correctement de manière à ce que les contacts dorés soient tournés vers l'écran de la dash cam. Poussez la carte mémoire jusqu'à ce qu'elle s'enclenche dans la fente.

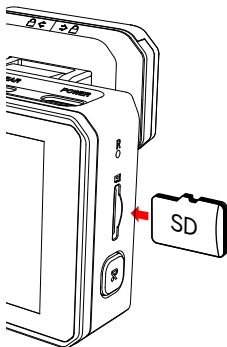

Pulsanti e Funzioni . . . . .	<b>53</b>
Funzione Touchscreen . . . . .	<b>55</b>
Funzione di Controllo Vocale . . . . .	<b>58</b>
Panoramica dell'interfaccia Utente . . . . .	<b>59</b>
Panoramica delle Funzioni . . . . .	<b>62</b>
Aggiornamento OTA (Wireless) . . . . .	<b>65</b>
Come Guardare un Video Su un Computer . . . . .	<b>65</b>
Impostazioni di Archiviazione . . . . .	<b>68</b>

## Pulsanti e Funzioni



### **Pulsante di Accensione**

Modalità di registrazione:

- Breve pressione per passare da una schermata all'altra
- Premere a lungo-per spegnere la fotocamera

Modalità di configurazione:

- Pressione breve - Accendere/spegnere lo schermo

Modalità di riproduzione:

- Pressione breve - Eliminare/bloccare/sbloccare il file specifico



### **Pulsante Menu**

Modalità di registrazione:

- Premere brevemente per accedere al menu principale

Modalità di configurazione:

- Pressione breve - Tornare alla schermata precedente

Modalità di riproduzione:

- Pressione breve - Tornare alla schermata precedente



### **Pulsante Sinistro**

Modalità di registrazione:

- Pressione breve - Bloccare/sbloccare il file di registrazione
- Pressione lunga - Accendere/spegnere il Wi-Fi

Modalità di configurazione:

- Premere brevemente per selezionare la funzione precedente

Modalità di riproduzione:

- Pressione breve - Riavvolgimento rapido durante la riproduzione del video



### **Pulsante Destro**

Modalità di registrazione:

- Pressione breve - Attivare/disattivare la registrazione audio

Modalità di configurazione:

- Premere brevemente per selezionare la funzione successiva

Modalità di riproduzione:

- Premere brevemente per selezionare il file successivo
- Premere brevemente per avanzare velocemente (durante la riproduzione del video)

### **Pulsante OK**

Modalità di registrazione:

- Pressione breve - Scattare una foto
- Pressione lunga - Attivare/disattivare il video

Modalità di configurazione:

- Pressione breve - Inserire/confermare impostazioni specifiche

Modalità di riproduzione:

- Pressione breve - Riprodurre il file specifico

## Funzione Touchscreen

- **Modalità video**

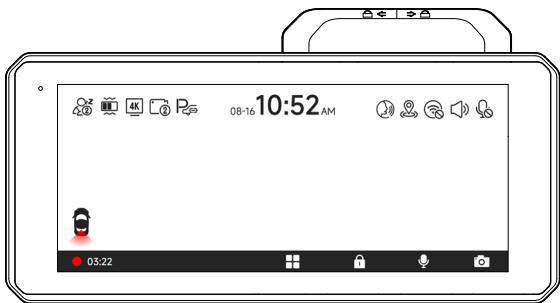

Puoi manualmente cliccare sul simbolo  in alto sul schermo per scegliere se registrare audio durante la registrazione video.

Puoi manualmente cliccare sul simbolo  in alto sul schermo per scegliere se attivare Wi-Fi.

Puoi manualmente cliccare sul simbolo  in alto sul schermo per scegliere se attivare il tono del tasto.

Puoi manualmente cliccare sul simbolo  in alto sul schermo per scegliere se attivare il controllo vocale.

## • Modalità di riproduzione

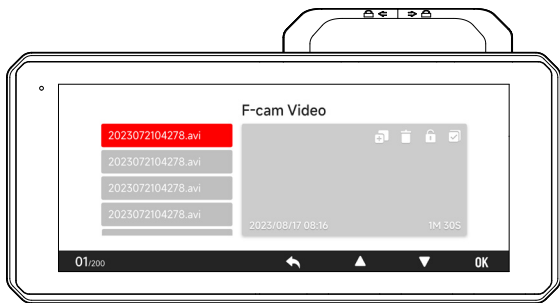

Scorri verso l'alto e verso il basso sull'interfaccia di riproduzione per girare le pagine.

Puoi fare clic manualmente sull'icona  per scegliere se copiare il contenuto dell'eMMC sulla scheda di memoria.

Puoi fare clic manualmente sull'icona  per scegliere se eliminare i file.

Puoi fare clic manualmente sull'icona  per scegliere se bloccare i file.

Puoi fare clic manualmente sull'icona  per scegliere se selezionare più file.

## • Modalità di impostazione

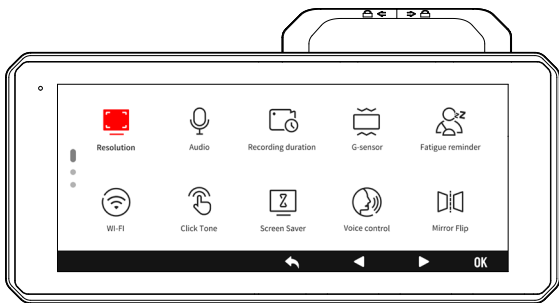

Scorri verso l'alto e verso il basso sull'interfaccia delle impostazioni per girare le pagine.

Puoi fare clic manualmente sull'icona per accedere all'interfaccia della funzione selezionata.

## Funzione Controllo Vocale

Controllo rapido tramite semplici comandi vocali.

Quando il simbolo  è bianco, significa che la funzione può essere usata normalmente.

Ci sono due modi per attivare questa funzione.

- 1 Tocca il simbolo per attivare o disattivare la funzione.
- 2 Vai a Impostazioni - Controllo vocale - ON/OFF.

lock the video	
take picture	
turn on Audio	turn off Audio
turn on screen	turn off screen
turn on wifi	turn off wifi
turn on recording	turn off recording
show front camera	show rear camera

### Nota:



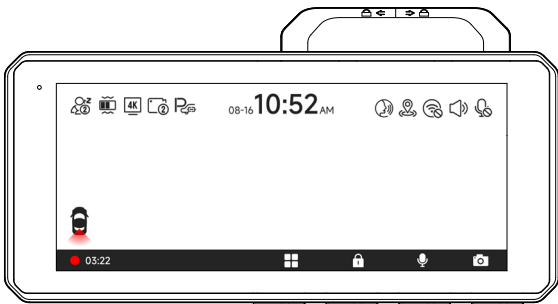

1. Puoi vedere comandi specifici nelle impostazioni del controllo vocale.
2. La funzione controllo vocale supporta solo inglese.

## Panoramica dell'interfaccia Utente

### • Modalità di registrazione



Icona	Descrizione
	La funzione di rilevamento della fatica è attiva
	Sensibilità del sensore G
	Risoluzione della fotocamera frontale
	Registrazione in loop di 1 min/3 min/5 min per file
	Se collegare il kit cablato e configurare il monitoraggio del parcheggio
	Controllo vocale

Icona	Descrizione
	Stato del GPS
	Stato del Wi-Fi
	Stato del suono del sistema della fotocamera
	Stato della registrazione vocale
	Quale fotocamera è visualizzata
	Stato di registrazione e tempo di registrazione
	Registrazione di emergenza attiva
	Data e ora della fotocamera
	Impostazioni
	Registrazione di emergenza
	Attivare o disattivare la registrazione
	Fotografia

## • Modalità di riproduzione

- 1 Premere il pulsante **M** per accedere alla modalità di riproduzione.
- 2 Premere il pulsante sinistro o destro per selezionare la cartella che si desidera riprodurre, quindi premere il pulsante **OK** per entrare.

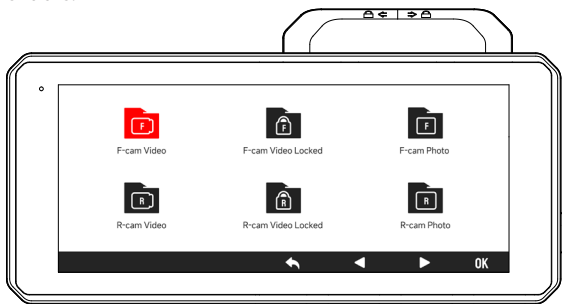



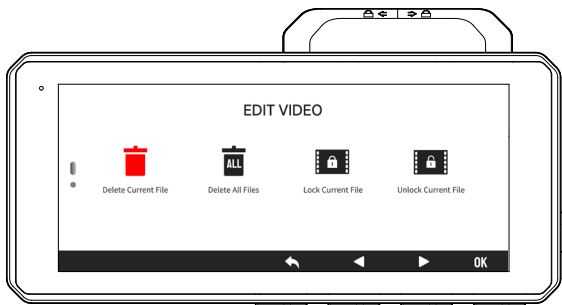











- 3 Premere il pulsante **OK** per guardare il video registrato.
- 4 Premere brevemente il pulsante di accensione per modificare i video registrati.











## Panoramica Delle Funzioni

Premere brevemente il pulsante M per accedere al menu delle impostazioni, dove è possibile regolare varie funzioni e parametri della fotocamera.

Icona	Funzione	Opzione/Descrizione
	Risoluzione	Anteriore 4K@30fps + Posteriore 4K@30fps Anteriore 2.5K@60fps + Posteriore 4K@30fps Anteriore 2.5K@30fps + Posteriore 4K@30fps Anteriore 4K@30fps / Anteriore 2.5K@60fps Anteriore 2.5K@30fps
	Audio	Acceso/Spento
	Durata Registrazione	1/3/5 Minuti
	Sensor G	Spento / Bassa / Media / Alta
	Avviso Fatica	1h / 2h / 3h / 4h / Spento
	Wi-Fi	SPENTO / 2.4GHz / 5.8GHz
	Tono Click	Acceso/Spento
	Screensaver	Spento / 10s / 30s / 2min, schermo si spegne dopo il tempo impostato
	Controllo Vocale	Acceso/Spento/Comando vocale
	Inversione Orizzontale	Inversione orizzontale della vista posteriore * Camera posteriore deve essere collegata

Icona	Funzione	Opzione/Descrizione
	Inversione Verticale Camera Posteriore	Inversione verticale della vista posteriore * Camera posteriore deve essere collegata
	Monitoraggio Parcheggio	Si prega di collegare il kit hardwire ACC
	GPS	Mostra segnale GPS
	Timestamp Data	Acceso/Spento
	Timestamp Velocità	Acceso/Spento
	Timestamp GPS	Acceso/Spento
	Unità Velocità	KM/H / MPH
	Lingua	Scegli la tua lingua preferita
	Impostazioni Orologio	Aggiorna con GPS
	Formato Orario	12h/24h
	Fuso Orario	Scegli il tuo fuso orario
	Ora Legale	Acceso/Spento

Icona	Funzione	Opzione/Descrizione
	Frequenza	60Hz/50Hz
	Promemoria Formattazione	Formatta per cancellare i dati
	Formatta SD Card	Formatta eMMC o scheda di memoria. Tutti i dati verranno eliminati.
	Test Velocità Scheda	Rilevamento velocità scheda
	Ripristino Impostazioni	Ripristina tutte le impostazioni
	APP	QR-Code per Redtiger App
	Versione	Versione software
	Centro Assistenza	Scansiona il QR-Code per contattare

## Nota:

- Per garantire un'esperienza utente fluida, si consiglia di formattare la scheda di memoria una volta al mese.
- Se si cambia la impostazione Tono click su OFF, anche i toni di attivazione e disattivazione saranno disabilitati.

## Aggiornamento OTA (Wireless)

**Nota:** Aggiornare l'app Redtiger alla versione più recente per utilizzare questa funzione.

1. Per eseguire un aggiornamento over-the-air, scollegare il telefono dalla rete Wi-Fi della Dash cam. Collegare il telefono alla rete LAN (non al Wi-Fi della Dash cam) per 5 secondi, quindi scollegare. Riconnettersi alla rete Wi-Fi della Dash cam.
2. Una volta stabilita la connessione Wi-Fi, aprire l'app Redtiger per utilizzarla. Se viene rilevato un nuovo software, la pagina App indicherà la disponibilità di un aggiornamento.
3. Per eseguire l'aggiornamento, fare clic su "Aggiorna ora". L'app Redtiger ti chiederà di scaricare il pacchetto di aggiornamento.
4. Collegare la Dash cam per inviare il pacchetto di aggiornamento. Non farlo spegnere la dash cam durante il processo di aggiornamento. Una volta l'aggiornamento è stato completato, l'app visualizzerà un messaggio di successo e la dash cam si riavvia automaticamente.

## Come Guardare un Video Su un Computer

Si consiglia di utilizzare REDTIGER Player come lettore video corretto per guardare/riprodurre video. Può anche visualizzare Google Maps.

È possibile scaricarlo gratuitamente su Mac o Windows dal collegamento seguente: <https://www.redtigerscam.com/pages/gps-player> puoi scegliere diverse modalità di riproduzione in Impostazioni > Video modalità di riproduzione. È possibile impostare la velocità di riproduzione, la lingua, la mappa, e varie altre funzioni.

## SUGGERIMENTI:

I dati possono essere inviati dall'unità principale a un personal computer tramite un cavo USB. In alternativa, è possibile inserire una scheda di memoria nella dash cam e copiare i dati dalla eMMC, trasferendoli con un lettore di schede.

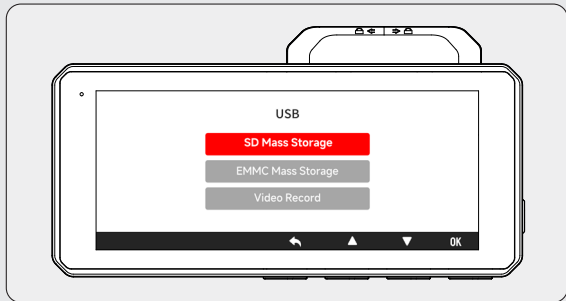
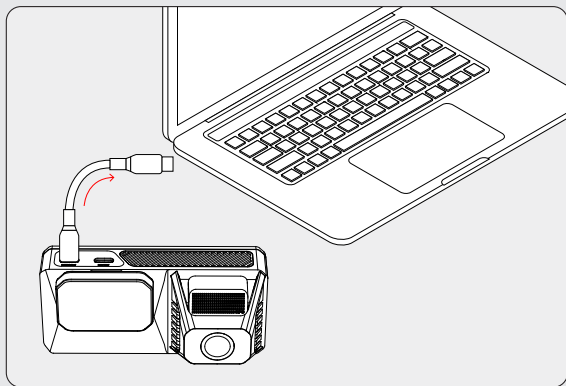

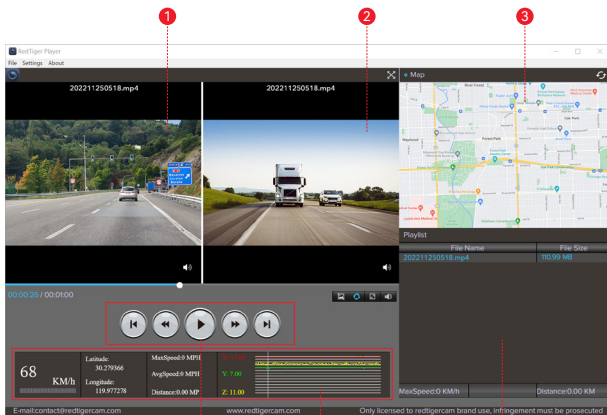

- 1 Finestra di riproduzione video (anteriore)
- 2 Finestra di riproduzione video (posteriore)
- 3 Visualizzazione mappa e traccia
- 4 Pannello di controllo riproduzione
- 5 Indicazione della velocità e dello stato di guida
- 6 Elenco di riproduzione

### Nota:

Se vengono registrati i file video delle tracce stradali anteriori e posteriori in sincronia e contemporaneamente caricate nell'elenco di riproduzione, possono essere riprodotte separatamente in due schermi separati a sinistra e a destra.

Una volta trovato il file video desiderato, tenere premuto il pulsante sinistro del mouse e trascinare i file desiderati nella finestra di riproduzione video per riprodurlo.

## Impostazioni di Archiviazione

### ⚠ ATTENZIONE

Assicurarsi di collegare tutte le videocamere e i cavi prima di accendere lo schermo della fotocamera, altrimenti la fotocamera non funzionerà correttamente. Seguire le istruzioni Di seguito per la prima installazione della Dash cam Redtiger.

### • Memoria eMMC

La dash cam è dotata di una memoria eMMC (Embedded Multi Media Card) da 128 GB integrata, che elimina la necessità di acquistare e installare una scheda di memoria aggiuntiva, consentendo la registrazione immediata all'avvio.

### • Inserimento della scheda di memoria (operazione opzionale)

L'F77 supporta anche l'uso di schede di memoria per copiare i video necessari. È possibile farlo nella cartella di riproduzione facendo clic su "Copia corrente" o "Copia selezionata".

Suggerimenti: I video non vengono salvati direttamente sulla scheda di memoria. Inserire la scheda di memoria nella dash cam, assicurandosi che sia orientata correttamente in modo che i contatti dorati siano rivolti verso lo schermo della dash cam. Spingere la scheda di memoria finché non scatta nello slot.

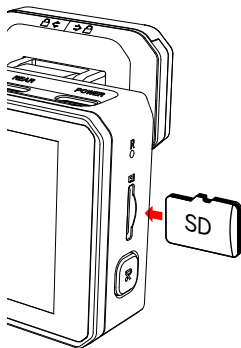

Botones y Funciones . . . . .	<b>70</b>
Función de Pantalla Táctil . . . . .	<b>72</b>
Función de Control Por Voz . . . . .	<b>75</b>
Interfaz de Usuario . . . . .	<b>76</b>
Descripción General de Funciones . . . . .	<b>79</b>
Actualizaciones Por Aire . . . . .	<b>82</b>
Cómo Reproducir Vídeo en el Ordenador . . . . .	<b>82</b>
Configuración de almacenamiento . . . . .	<b>85</b>

## Botones y Funciones



### Botón de encendido

Modo de grabación:

- Pulsación corta - para cambiar de pantalla
- Pulsación larga - para apagar la cámara

Modo de configuración:

- Pulsación corta - para Activar/ Desactivar pantalla

Modo de reproducción:

- Pulsación corta - para Borrar/ Bloquear/ Desbloquear el archivo específico



### Botón de menú

Modo de grabación:

- Pulsación corta - para entrar en el menú principal  
Modo de configuración

Modo de configuración:

- Pulsación corta - para volver a la pantalla anterior

Modo de reproducción:

- Pulsación corta - para volver a la pantalla anterior



### Botón izquierdo

Modo de grabación:

- Pulsación corta - para bloquear el archivo de grabación
- Pulsación larga - para activar o desactivar el Wi-Fi

Modo de configuración:

- Pulsación corta - para seleccionar la función anterior

Modo de reproducción:

- Pulsación corta - para seleccionar el archivo anterior
- Pulsación corta - para rebobinar rápidamente (mientras se reproduce el vídeo)



## Botón derecho

Modo de grabación:

- Pulsación corta-para Activar/ Desactivar grabación de audio

Modo de configuración:

- Pulsación corta - para seleccionar la función siguiente

Modo de reproducción:

- Pulsación corta - para seleccionar el archivo siguiente
- Pulsación corta - para avanzar rápidamente (mientras se reproduce el vídeo)

## Botón OK

Modo de grabación:

- Pulsación corta - para tomar una instantánea
- Pulsación larga - para detener la grabación

Modo de configuración:

- Pulsación corta - para Introducir/Confirmar ajustes específicos

Modo de reproducción:

- Pulsación corta - para seleccionar y reproducir el archivo específico

## Función de Pantalla Táctil

- **Modo de Vídeo**

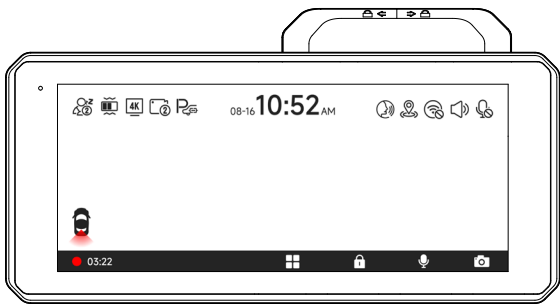

Puede hacer clic manualmente en el ícono  situado en la parte superior de la pantalla para elegir si desea grabar audio durante la grabación de vídeo

Puede hacer clic manualmente en el ícono  situado en la parte superior de la pantalla para elegir si desea activar el Wi-Fi

Puede hacer clic manualmente en el ícono  situado en la parte superior de la pantalla para elegir si desea activar el sonido de la tecla

Puede hacer clic manualmente en el ícono  situado en la parte superior de la pantalla para elegir si desea activar el control de voz

## • Modo de Reproducción

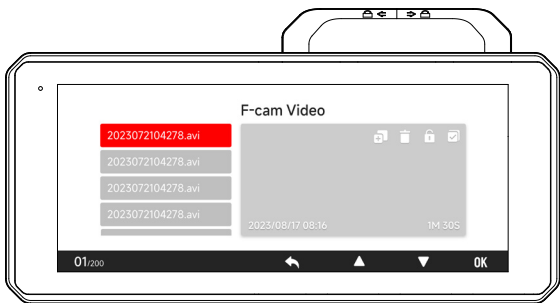

Deslice hacia arriba y hacia abajo en la interfaz de reproducción para pasar página.

Puede hacer clic manualmente en el icono  para elegir si copiar el contenido de emmc a la tarjeta de memoria.

Puede hacer clic manualmente en el icono  para elegir si eliminar el archivo.

Puede hacer clic manualmente en el icono  para elegir si bloquear el archivo.

Puede hacer clic manualmente en el icono  para elegir si selecciona varios archivos.

## • Establecer Modo

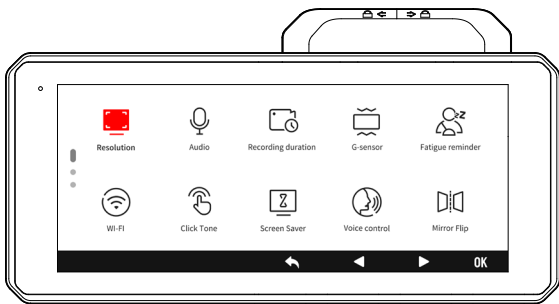

Deslice hacia arriba y hacia abajo en la interfaz de configuración para pasar página.

Puede hacer clic manualmente en el icono para ingresar a la interfaz de función seleccionada.

## Función de Control Por Voz

Control rápido a través de comandos de voz simples

Si el icono es blanco



significa que la función puede ser utilizada normalmente.

Tiene dos maneras de habilitar esta función.

- 1 Toque en el icono para activar o desactivar la función.
- 2 Introduzca el modo de ajuste-voice control-on/off.

lock the video	
take picture	
turn on audio	turn off audio
turn on screen	turn off screen
turn on wifi	turn off wifi
turn on recording	turn off recording
show front camera	show rear camera

### Nota:







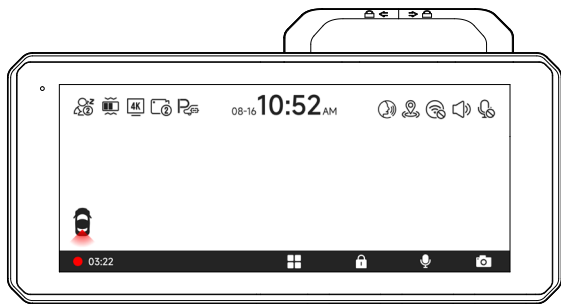



1. Puede ver los comandos específicos en el control setting-voice.
2. la función de control de voz solo admite inglés.

# Interfaz de Usuario

## • Modo de grabación



Icono	Descripción
	Función de conducción cansada activada
	Sensibilidad del sensor G
	Resolución de la cámara frontal
	Grabación en bucle de 1 min/3 min/5 min por archivo
	Posibilidad de conectar el kit de cableado y configurar el control de aparcamiento
	Control por voz

Icono	Descripción
	Estado del GPS
	Estado de Wi-Fi
	Estado del sonido del sistema de cámara
	Estado de la grabación de voz
	Qué cámara se está visualizando
 03:22	Estado y tiempo de grabación
 03:22	Grabación de emergencia activada
08-16 10:52 AM	Fecha y hora de la cámara
	Ajustes
	Grabación de emergencia
	Activar o desactivar la grabación
	Fotografía

## • Playback mode

- 1 Pulse el botón **M** para entrar en el modo de reproducción.
- 2 Pulse el botón Izquierda o derecha para seleccionar la carpeta que desee reproducir y, a continuación, pulse el botón **OK** para entrar.

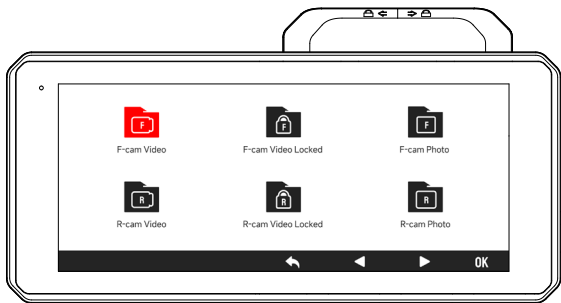

- 3 Pulse el botón **OK** para ver el vídeo grabado.
- 4 Pulse el botón de encendido para editar los vídeos grabados.

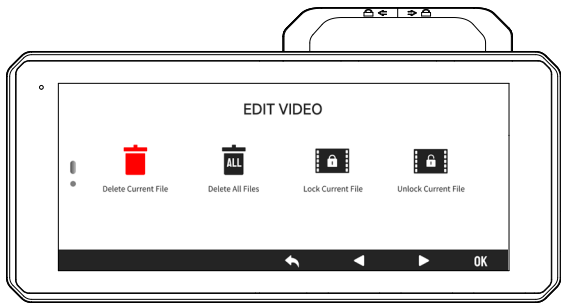







## Descripción General de Funciones

Pulse brevemente el botón M para acceder al menú de configuración, donde podrá ajustar varias funciones.

Icono	Función	Opción/Descripción
	Resolución	Frontal 4K@30fps+Trasera 4K@30fps / Frontal 2.5K@60fps+Trasera 4K@30fps/ Frontal 2.5K@30fps+Trasera 4K@30fps/ Frontal 4K@30fps/Frontal 2.5K@60fps/ Frontal 2.5K@30fps
	Audio	Grabación de sonido Encendido/Apagado
	Grabación en Bucle	1/3/5 minutos
	Sensor G	Apagado/Bajo/Medio/Alto
	Conducción Fatigada	Se realizará un recordatorio durante 1 hora /2 horas/3 horas/Apagado
	Wi-Fi	APAGADO/2.4GHz/5.8GHz
	Tono de Clic	Encendido/Apagado
	Protector de Pantalla	Apagado/10 segundos/30 segundos/2 minutos La pantalla se apaga después del tiempo establecido
	Control de Voz	Encendido/Apagado/Comando de voz
	Voltear Espejo	Voltear la vista frontal horizontalmente

Icono	Función	Opción/Descripción
	Voltear Cámara Trasera	Voltear la vista trasera verticalmente
	Modo de Aparcamiento	Conecte el kit de cableado ACC
	GPS	Muestra la intensidad de la señal GPS
	Sello de Fecha	Sello Encendido/Apagado
	Sello de Velocidad	Sello Encendido/Apagado
	Sello GPS	Sello Encendido/Apagado
	Unidades de Velocidad	KM/H / MPH
	Idioma	Seleccione su idioma preferido
	Fecha / Hora	Actualizar con GPS
	Formato de Hora	12h/24h
	Zona Horaria	Elija su zona horaria
	DST	Horario de verano Encendido/Apagado

Icono	Función	Opción/Descripción
	Frecuencia	60Hz/50Hz
	Recordatorio de Formato	Recordatorio para borrar datos
	Formatear	Formatee la tarjeta de memoria Se borrarán todos los datos
	Velocidad de la Tarjeta	Detección de la velocidad de la tarjeta
	Ajuste por Defecto	Restablecer todos los ajustes
	APP	Un código QR para la Redtiger App
	Versión	Versión del software
	Centro de Ayuda	Escanee el código QR para ponerse en contacto con nosotros

## Nota:

- Para garantizar una experiencia de usuario sin problemas, se recomienda formatear el almacenamiento eMMC una vez al mes.
- Cuando ajuste la opción Tono de clic a APAGADO, también se apagarán los sonidos de arranque y apagado.

## Actualizaciones Por Aire

**Note:** Para utilizar esta función, actualice la Redtiger App a la versión más reciente.

1. Para realizar una actualización por aire, desconecte su teléfono de la red Wi-Fi de la cámara para tablero. Conecte su teléfono a la red LAN (no a la Wi-Fi de la cámara para tablero) durante 5 segundos antes de desconectarlo. Vuelva a conectarlo a la red Wi-Fi de la cámara para tablero.
2. Una vez establecida la conexión Wi-Fi, inicie la Redtiger App para comenzar a utilizarla. Si se detecta un nuevo software, la página de la App mostrará la disponibilidad de una actualización.
3. Para iniciar la actualización, haga clic en "Actualizar ahora". La Redtiger App le pedirá que descargue el paquete actualizado.
4. Conecte la cámara para tablero para enviar el paquete de actualización. No apague la cámara para tablero durante el procedimiento de actualización. Cuando la actualización haya finalizado, la App mostrará un mensaje de actualización correcta y la cámara para tablero se reiniciará automáticamente.

## Cómo Reproducir Vídeo en el Ordenador

Recomendamos utilizar REDTIGER Player como reproductor de vídeo correcto para ver/reproducir vídeos. También puede ver Google Maps.

Puedes descargarlo gratis en Mac o Windows desde el siguiente enlace: <https://www.redtigerscam.com/pages/gps-player>

Puede elegir diferentes modos de reproducción en Ajustes > Modo de reproducción de vídeo. Puede ajustar la velocidad de reproducción, el idioma, el mapa y otras funciones.

## CONSEJOS:

Los datos pueden ser enviados desde la unidad principal a un ordenador personal mediante un cable USB.

Alternativamente, puede insertar una tarjeta SD en la cámara del tablero y copiar datos desde el eMMC, transferir datos mediante un lector de tarjetas.

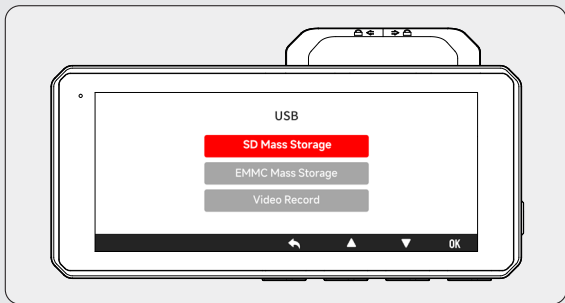
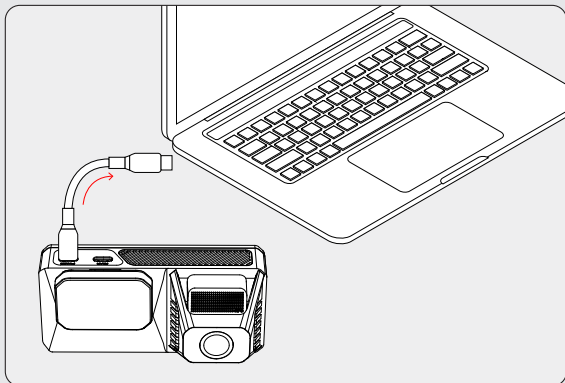

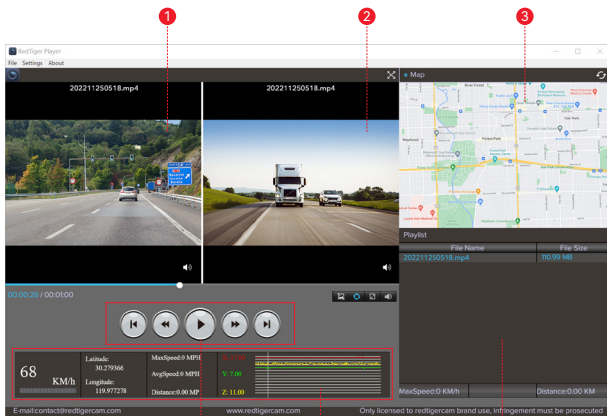

- 1 Ventana de reproducción de vídeo (Frontal)
- 2 Ventana de reproducción de vídeo (trasera)
- 3 Visualización de mapas y rutas
- 4 Panel de control de reproducción
- 5 Indicación de velocidad y estado de conducción
- 6 Lista de reproducción

### Nota:

Si los archivos de vídeo de las pistas de carretera delantera y trasera se graban de forma sincronizada y se cargan en la lista de reproducción al mismo tiempo, pueden reproducirse por separado en las pantallas izquierda y derecha divididas.

Cuando encuentre el archivo de vídeo elegido, mantenga pulsado el botón izquierdo del ratón y arrástrelo a la ventana de reproducción de vídeo para iniciarlo.

## Configuración de almacenamiento

### ⚠ ADVERTENCIA

Asegúrese de que todas las cámaras y cables están conectados antes de encender la pantalla de la cámara; de lo contrario, la cámara no funcionará correctamente. Para instalar por primera vez la cámara para tablero Redtiger, siga las siguientes instrucciones.

#### • Almacenamiento eMMC

La cámara del salpicadero viene con almacenamiento integrado de 128 GB eMMC (Tarjeta Multimedia Integrada), eliminando la necesidad de comprar e instalar una tarjeta de memoria adicional, lo que permite la grabación inmediata al inicio.

#### • Inserte la tarjeta de memoria (Operación Opcional)

También es compatible con F77 usando tarjetas de memoria para copiar los videos que necesita. Puede hacer esto en la carpeta de reproducción haciendo clic en "Copiar actual" o "Copia seleccionada."

Consejos: El vídeo no se guarda directamente en la tarjeta de memoria. Introduzca la tarjeta de memoria en la cámara para tablero, asegurándose de que está orientada correctamente, de forma que los contactos dorados queden mirando hacia la pantalla de la cámara para tablero. Empuje la tarjeta de memoria hasta que encaje en la ranura.

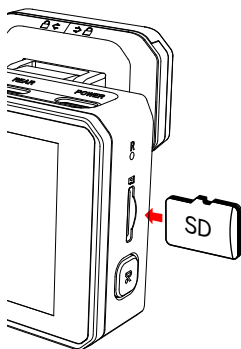

## Customer Service Center

If you have any problems with the function or installation of your dash cam, please feel free to reach out to us.



Help Center



WhatsApp



### For more information:

After sales: [help@redtigercam.com](mailto:help@redtigercam.com)

Business Cooperation: [contact@redtigercam.com](mailto:contact@redtigercam.com)

Customer Phone Service: +1 888 966 8028 (US)



# REDTIGER

Truly Peace of Mind

Check us out here.  
Product and service are the foundation of Redtiger.

Instagram: @redtiger\_dashcam  
Facebook: Redtiger Dash Cam



[www.redtigercam.com](http://www.redtigercam.com)