



**BLACKVUE™**

**Quick Start Guide**

**DR770X-2CH LTE**

**DR970X-2CH LTE**

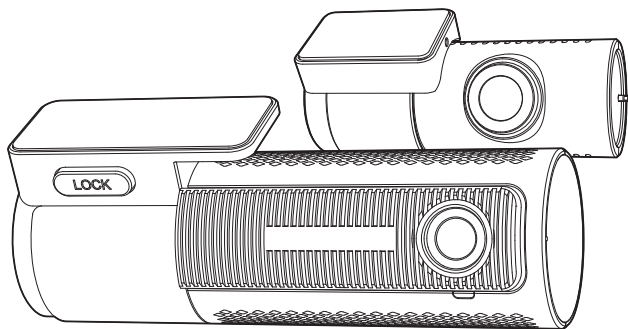

ENGLISH/日本語

[www.blackvue.com](http://www.blackvue.com)



Detailed Manual

# BLACKVUE

---

DR770X-2CH LTE | DR970X-2CH LTE

For manuals, customer support and FAQs go to [www.blackvue.com](http://www.blackvue.com)  
取扱説明書、カスタマーサポート、およびFAQ (よくあるご質問) については  
BlackVue ウェブサイト ([www.blackvue.com](http://www.blackvue.com)) をご覧ください。

## Important safety information

---

For user safety and to avoid property damage, read through this manual and follow these safety instructions to use the product correctly.

- Do not disassemble, repair, or modify the product yourself.  
Doing so may cause fire, electric shock, or malfunction. For internal inspection and repair, contact the service center.
- Do not adjust the product while driving.  
Doing so may cause an accident. Stop or park your car in a safe place before installing and setting up the product.
- Do not operate the product with wet hands.  
Doing so may cause electric shock.
- If any foreign matter gets inside the product, detach the power cord immediately.  
Contact the service center for repair.
- Do not cover the product with any material.  
Doing so may cause external deformation of the product or fire. Use the product and peripherals in a well-ventilated location.
- If the product is used outside the optimal temperature range, performance can decline or malfunctions may occur.
- When entering or exiting a tunnel, when directly facing into bright sunlight, or when recording at night without lighting the quality of recorded video may deteriorate.
- If the product is damaged or the power supply is cut due to an accident, video may not be recorded.
- Do not remove the microSD card while the microSD card is saving or reading data.  
The data can be damaged or malfunctions may occur.

## FCC Compliance Information

---

This equipment has been tested and found to comply with the limits for a Class B digital device, pursuant to Part 15 of the FCC Rules. These limits are designed to provide reasonable protections against harmful interference in a residential installation.

This equipment generates, uses and can radiate radio frequency energy and, if not installed and used in accordance with the instructions, may cause harmful interference to radio communications. However, there is no guarantee that interference will not occur in a particular installation.

If this equipment does cause harmful interference to radio or television reception which can be determined by turning the equipment off and on, the user is encouraged to try to correct the interference by one or more of the following measures.

- Reorient or relocate the receiving antenna.
- Increase the separation between the equipment and receiver.
- Connect the equipment into an outlet on a circuit different from that to which the receiver is connected.
- Consult the dealer or an experienced radio, TV technician for help.
- Only shielded interface cable should be used.

Finally, any changes or modifications to the equipment by the user not expressly approved by the grantee or manufacturer could void the user's authority to operate such equipment.

This device complies with Part 15 of the FCC Rules. Operation is subject to the following two conditions:

- (1) This device may not cause harmful interference, and
- (2) This device must accept any interference received, including interference that may cause undesired operation of this device.

**FCC ID: YCK-BV7LTE, YCK-DR970XLTE**

## CAUTION

Any changed or modifications in construction of this device which are not expressly approved by the party responsible for compliance could void the user's authority to operate the equipment.

There is a risk of explosion if the battery is replaced by an incorrect type.  
Dispose of used batteries according to the instructions.

## CE WARNING

- Changes and modifications not expressly approved by the party responsible for compliance could void the user's authority to operate the equipment.
- It is desirable that it be installed and operated with at least 20cm or more between the radiator and a person's body (excluding extremities: hand, wrists, feet, and ankles).

## Disposal of your BlackVue dashcam

---



1. All electrical and electronic products should be disposed of separately from the municipal waste stream via designated collection facilities appointed by the government or the local authorities. Contact local authorities to learn about disposal and recycling options available in your area.
2. The correct disposal of your BlackVue dashcam will help prevent potential negative consequences for the environment and human health.
3. For more detailed information about disposal of your BlackVue dashcam, please contact your city office, waste disposal service or the shop where you purchased the product.

## IC Compliance

---

This Class [B] digital apparatus complies with Canadian ICES-003.

This radio transmitter has been approved by Industry Canada to operate with the antenna types listed below with the maximum permissible gain and required antenna impedance for each antenna type indicated. Antenna types not included in this list, having a gain greater than the maximum gain indicated for that type, are strictly prohibited for use with this device.

### - IC Warning

This device complies with Industry Canada licence-exempt RSS standard(s).

Operation is subject to the following two conditions:

- (1) this device may not cause interference, and
- (2) this device must accept any interference, including interference that may cause undesired operation of the device.

Le présent appareil est conforme aux CNR d'Industrie Canada applicable aux appareils radio exempts de licence.

L'exploitation est autorisée aux deux conditions suivantes:

- (1) l'appareil ne doit pas produire de brouillage, et
- (2) l'utilisateur de l'appareil doit accepter tout brouillage radioélectrique subi, même si le brouillage est susceptible d'encompromettre le fonctionnement.

## In the box

Check the box for each of the following items before installing the BlackVue dashcam.

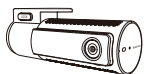

Front camera



Rear camera connection cable



Rear camera

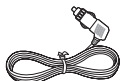

Cigarette lighter power cable

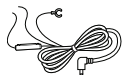

Hardwiring power cable



Quick start guide

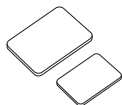

Double-sided tape for the Mounting Brackets



Cable clips (8 EA)



SIM eject tool



microSD card reader



microSD card



SIM card (optional)



Pry tool

### Need help?

Download the manual (including FAQs) and the latest firmware from [www.blackvue.com](http://www.blackvue.com)

Or contact a Customer Support expert at [cs@pittasoft.com](mailto:cs@pittasoft.com)

## At a glance

The following diagrams explain each part of the BlackVue dashcam.

### Front camera

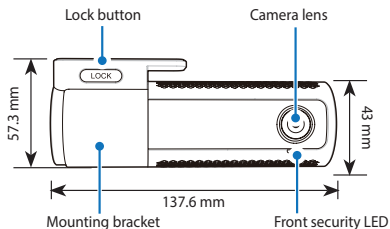

- : Lights on during (i) normal mode, (ii) an event is being recorded (impact detected), (iii) manual recording has started, or (iv) motion is detected in parking mode.
- ◻ : Blinks slowly during parking mode motion detection standby.

#### GPS LED

- : Lights blue when GPS is on.
- ⊙ : Blinks blue slowly when GPS is turning off.

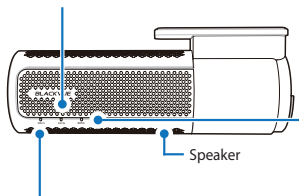

#### B/W/L (Bluetooth, Wi-Fi, LTE) LED

- : Lights yellow when LTE is connected.
- : Lights white when Wi-Fi is connected.
- : Blinks yellow quickly when Bluetooth is in pairing mode.
- : Blinks yellow slowly when Bluetooth is paired.

#### Recording LED

- : Lights orange in normal mode.
- : Lights red when (i) an event is being recorded (impact detected), or (ii) manual recording has started.
- : Lights green in parking mode when motion is detected.

## Connectivity details label:

- Default Wi-Fi SSID
- Default Wi-Fi password
- Cloud code
- Serial number
- QR code
- IMEI number

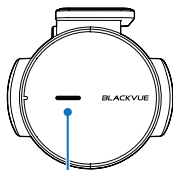
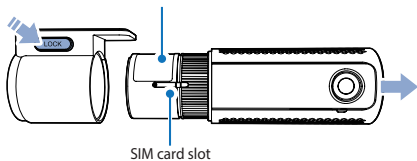

## Touch sensor:

Press the sensor to trigger a manual recording.

\* Touch sensor can be turned on/off in the firmware settings.

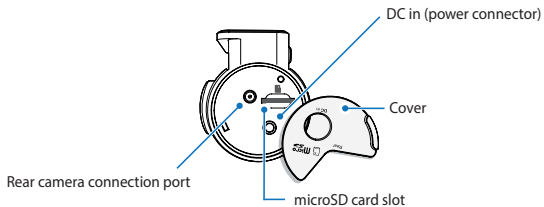

□ Rear camera

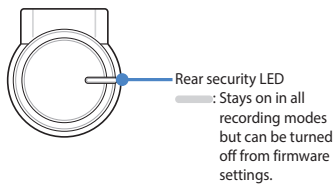
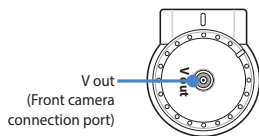
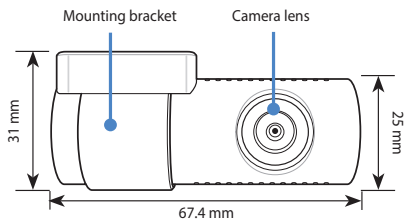

## STEP 1 Install and power up

Install the front camera behind the rear view mirror. Install the rear camera at the top of the back windshield. Remove any foreign matter and clean and dry the windshield before installation.

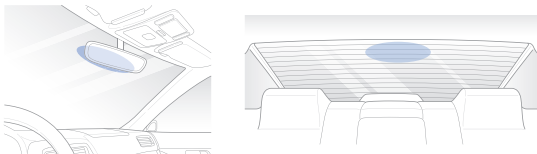

### Note

- Make sure to peel the protective film off the front and rear camera. The cameras could be damaged from overheating if the protective film is not removed.

### Warning

- Do not install the product in a location where it can obstruct the driver's field of vision.

- A** Turn off the engine. Open the cover of the microSD card slot, gently push the card into the slot until it locks into place and close the cover.



- B** To insert the SIM card, remove the bracket from the front camera. Unmount the SIM slot by using SIM eject tool. Insert the SIM card into the SIM card slot. Then, Mount the SIM Slot back into the camera.



 **Note**

- BlackVue LTE series is only compatible with 4G LTE network.
- For detailed information about activation of SIM card, please visit BlackVue Help Center: <https://helpcenter.blackvue.com> -> **SIM Activation Guide (LTE Series)**.

- C** Peel off the protective film from the double-sided tape and attach the front camera to the windshield behind the rear-view mirror.

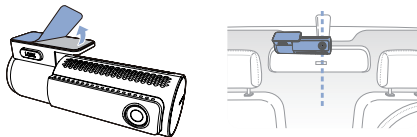

- D** Adjust the angle of the lens by rotating the body of the front camera. We recommend pointing the lens slightly downwards ( $\approx 10^\circ$  below horizontal), so as to record video with a 6:4 road to background ratio.

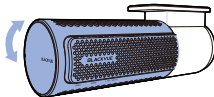

- E** Peel off the protective film from the double-sided tape and attach the rear camera to the back windshield. Adjust the angle of the lens by rotating the body of the camera.

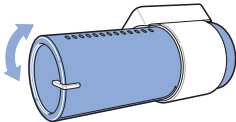

- F** Plug the right angle connector of the rear camera connection cable to the front camera ('Rear' port).

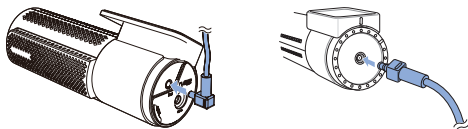

- G** Use the pry tool to lift the edges of the rubber window sealing and/or molding and tuck in the rear camera connection cable.

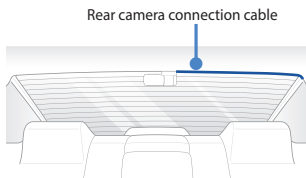

- H** Plug the cigarette lighter power cable into the cigarette lighter socket and the front camera. Skip to **L** for Hardwiring Power Cable setup.

- I Use the pry tool to lift the edges of the windshield trim/molding and tuck in the power cord.

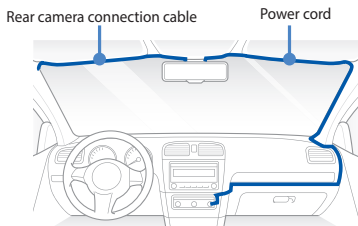

- J Turn on the engine. The BlackVue dashcam will power up and start recording. Video files are stored on the microSD card.
- K Turn off the engine. The dashcam will automatically stop recording and power down. To record in parking mode while the engine is off please connect the Hardwiring Power Cable (included in the box) or install a **Power Magic Battery Pack** (sold separately). A **Hardwiring Power Cable** uses the automotive battery to power your dashcam when the engine is off. A low voltage power cut-off function and a parking mode timer to protect the automotive battery from discharge is installed in the device. Settings can be changed in the BlackVue App or Viewer.
- L Locate the fuse box to connect the hardwiring power cable.

 **Note**

- Location of the fuse box differ by manufacturer or model. For details, refer to the vehicle owner's manual.

- L-1** After removing fuse panel cover, find a fuse that powers on when engine is turned on (ex. cigarette lighter socket, audio, etc) and another fuse that remains powered on after the engine is turned off (ex. hazard light, interior light). Connect the ACC+ cable to a fuse that powers on after engine start, and BATT+ cable to a fuse that remains powered on after engine is turned off.

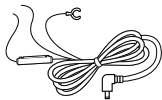

**Note**

- To use battery saver feature, connect the BATT+ cable to the hazard light fuse. Functions of fuse differ by manufacturer or model. For details refer to the vehicle owner's manual.

- L-2** Connect the GND cable to metal ground bolt.

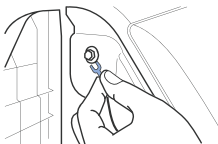

- M** Connect the power cable to the DC terminal of the front camera. BlackVue will power up and start recording. Video files are stored on the microSD card.

**Note**

- When you run the dashcam for the first time the firmware is automatically loaded onto the microSD card. After the firmware has been loaded onto the microSD card you can customize settings using the BlackVue app on a smartphone or BlackVue Viewer on a computer.

## ➤ Using BlackVue app

### ☐ App overview

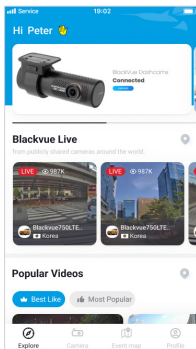

\*Image shown is the BlackVue app home screen

### **Explore**

- See the latest product and marketing information from BlackVue. Also watch popular video uploads and live views shared by BlackVue users.

### **Camera**

- Add and remove camera. Watch recorded videos, check camera status, change the camera settings and use Cloud functions of cameras added to the camera list.

### **Event map**

- See all the events and uploaded videos on the map shared by BlackVue users.

### **Profile**

- Review and edit account information.

## ❑ Register BlackVue account

- (A) Search for the BlackVue app in the Google Play Store or Apple App Store and install it on your smartphone.
- (B) Create an account
  - (i) Select **Login** if you have an account, otherwise tap **create account**.
  - (ii) During sign up, you will receive an e-mail with confirmation code. Enter the confirmation code to finish creating your account.

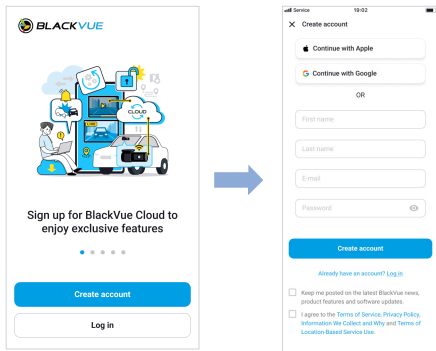

## □ Add BlackVue dashcam to camera list

Ⓒ Choose one of the following methods to add your BlackVue dashcam to the camera list. Once your camera is added, continue to the steps in 'Connect to Blackvue Cloud'.

### Ⓒ-1 Add via Seamless Pairing

- (i) Select **Camera** in the Global Navigation Bar.
- (ii) Find and Press + **Camera**.
- (iii) Select **Seamless Pairing models**. Make sure smartphone's Bluetooth is turned on.

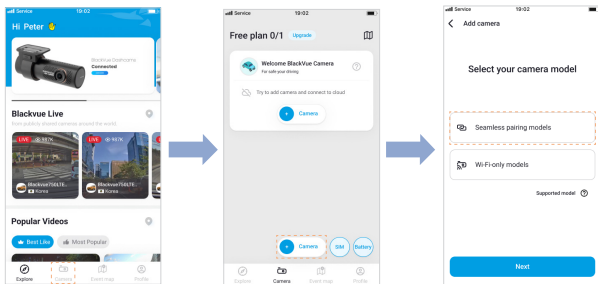

- (iv) Choose your BlackVue dashcam from the detected camera list.
- (v) Put your hand on the camera's touch sensor to complete seamless pairing.

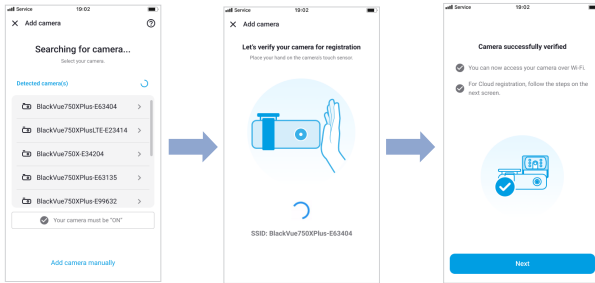

### C-2 Add manually

- (i) If you want to connect to camera manually, press **Add camera manually**.
- (ii) Press **How to connect phone to the camera** and follow the instructions.

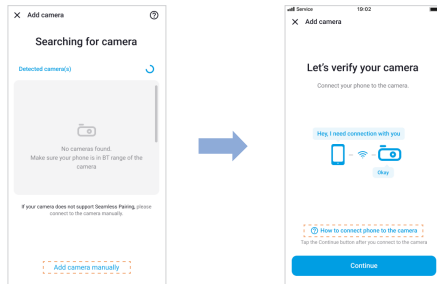

### Note

- Bluetooth and/or Wi-Fi direct has a connection range of 10m between your dashcam and smartphone.
- Dashcam SSID is printed in connectivity details label attached on your dashcam or inside the product box.

## □ Connect to BlackVue Cloud

You can use the BlackVue app to connect to BlackVue Cloud and see in real-time where your car is and the dashcam's live video feed.

For more information about using the BlackVue app, please refer to the BlackVue App manual from <https://cloudmanual.blackvue.com>.

- ⓓ Choose one of the following Cloud connection method. Once setup is complete, continue to steps in 'Quick settings'.

### ⓓ-1 Activate SIM card (BlackVue SIM card / 3rd party SIM card)

There are BlackVue SIM card which is included in BlackVue SIM package and 3rd party SIM card. It will be detected automatically. Follow the below steps for SIM registration.

- (i) Insert the SIM card as shown on **STEP 1** ⓑ.
- (ii) After your camera is added, the app will give you the option to choose a cloud connection method.
- (iii) Select **SIM card**

#### • In case of BlackVue SIM card

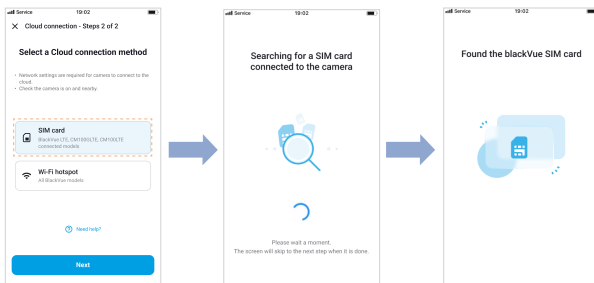

(iv) Confirm the SIM ICCID number and press Next.

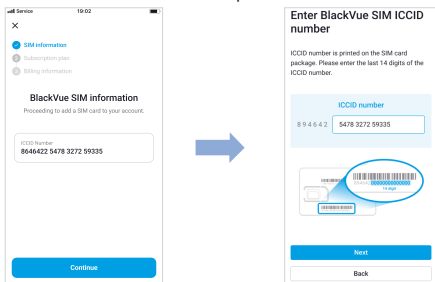

(v) Check your free trial information and precautions, press **Next**.

(vi) Input billing information and press **Try 1 month free**.

(vii) BlackVue SIM card subscription is done, Check your data plan and billing date and press **OK**.

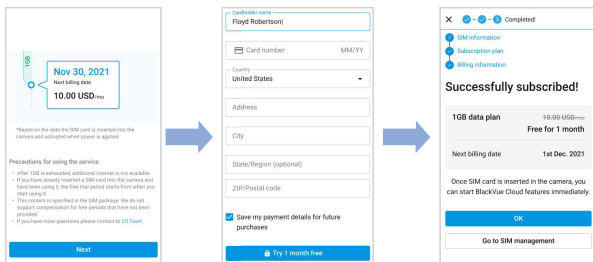

Once SIM card is inserted in the camera, SIM card will be activated automatically.

### Note

- For full details, please visit BlackVue website: [www.blackvue.com](http://www.blackvue.com) > **Helpcenter > Sim Activation Guide (LTE Series)**.
- If you want to manage your billing information, press **Go to SIM management**.

Go to **BlackVue SIM card** in the main home to manage your BlackVue SIM card.

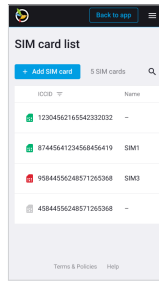
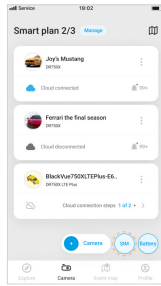

- **In case of 3rd party SIM card**

- Select **SIM card**
- Configure the APN settings to activate the SIM card and press Done.

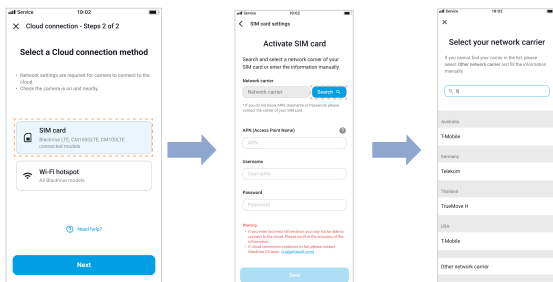

 **Note**

- To use the BlackVue Cloud Service, SIM card must be properly activated for Internet access via LTE network.
- When the dashcam is connected to internet, you can use BlackVue Cloud features such as remote Live View and Video playback, Real-time location, push notification, Auto-upload, remote Firmware update etc. on BlackVue app and PC Viewer.
- Some Cloud features may not work when surrounding temperature in high and/or LTE speed is slow.

## D-2 Wi-Fi hotspot

Make sure your BlackVue dashcam and mobile Wi-Fi hotspot are on.

(i) Select **Wi-Fi hotspot**.

(ii) Choose your Wi-Fi hotspot from the list. Enter the password and tap **Save**.

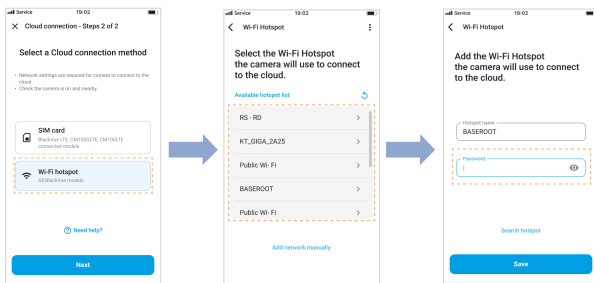

### Note

- Wi-Fi hotspot SSIDs can be saved (e.g. home, portable hotspot and work).
- The DR770X-2CH LTE dashcam is not compatible with 5GHz wireless networks.
- To add or make changes to your cloud connection methods, go to **Connect to Cloud**, tap  next to your dashcam model and select **Cloud connection settings**.

Setup is complete. your dashcam will automatically establish internet connection. If internet connection is not established, please ensure Wi-Fi information was inserted correctly.

Select **Connect to Cloud** from the main screen to access all of the Cloud features.

- If LTE and Wi-Fi hotspot is available for internet connection, Wi-Fi hotspot will be in priority. If LTE connection is preferred at all times, please remove Wi-Fi hotspot information.

## □ Quick settings (optional)

ⓔ Choose your preferred settings. Quick settings allow you to choose your FW language, time zone, and speed unit. If you prefer to do this later, press **skip**. Otherwise, press **next**.

(i) Select the firmware language for your BlackVue dashcam. Press **next**.

(ii) Select a time zone of your location. Press **next**.

(iii) Select the speed unit of your preference. Press **next**.

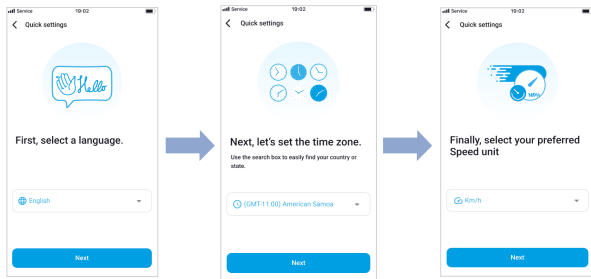

- (iv) Press **more settings** to access all of the settings or press **save**. Your dashcam will format the SD card to apply the settings. Press **OK** to confirm.
- (v) BlackVue dashcam installation is complete.

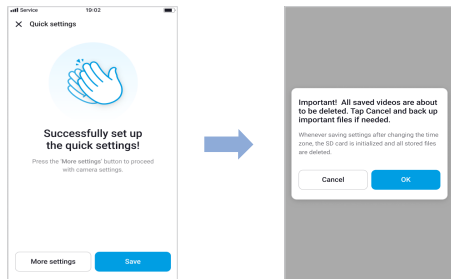

## □ Playing video files and changing settings

After installation is complete, follow the below steps to play video files and change settings.

- (A) Select **Camera** on your Global Navigation Bar.
- (B) Tap your dashcam model in the camera list.
- (C) To play video files, press **Playback** and tap the video you want to play.
- (D) To change the settings, press  settings.

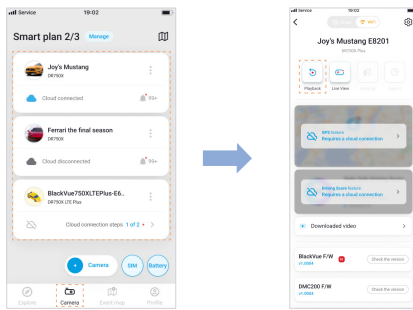

### Note

- For more information about BlackVue app, go to <https://cloudmanual.blackvue.com>.

## ▶ Using BlackVue Web Viewer

To experience the camera features in the Web Viewer, you must create an account and your dashcam must be connected to the Cloud. For this setup, it is recommended to download the BlackVue app and follow the instructions including optional steps in [Using BlackVue App](#) prior to accessing the Web Viewer.

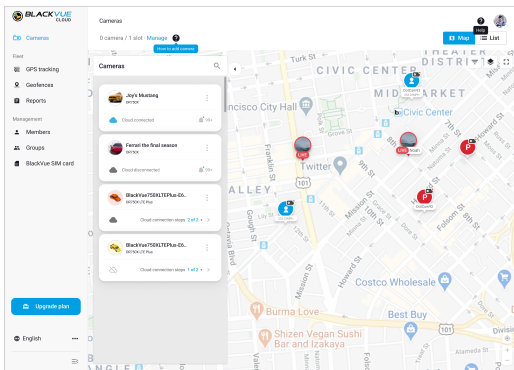

- A** Go to [www.blackvuecloud.com](http://www.blackvuecloud.com) to access BlackVue Web Viewer.
- B** Select **Start Web Viewer**. Enter the login information if you have an account, otherwise press **Sign up** and follow the guidelines in the Web Viewer.
- C** To play video files after login, select your camera in the camera list and press **Playback**. If you have not already added your camera, press **Add camera** and follow the guidelines in the Web Viewer.
- D** Select the video you want to play from the video list.

### **Note**

- For more information about BlackVue Web Viewer features, refer to the manual from <https://cloudmanual.blackvue.com>.

## ▶ Using BlackVue Viewer

### □ Playing video files and changing settings

- (A) Remove the microSD card from the dashcam.

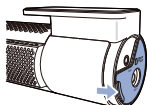

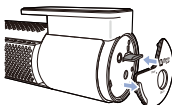

Open side cover

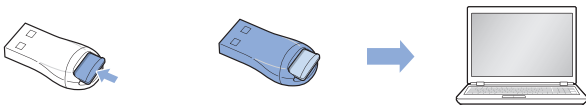

To remove

- (B) Insert the card into the microSD card reader and connect it to a computer.



- (C) Download BlackVue Viewer program from [www.blackvue.com](http://www.blackvue.com) > **Support** > **Downloads** and install it on your computer.
- (D) Run BlackVue Viewer. To play, select a video and click on the play button or double click the selected video.
- (E) To change settings, click on the  button to open the BlackVue settings panel. Settings that can be changed include Wi-Fi SSID & password, image quality, sensitivity settings, voice recording on/off, speed unit (km/h, MPH), LEDs on/off, voice guidance volume, Cloud settings etc.

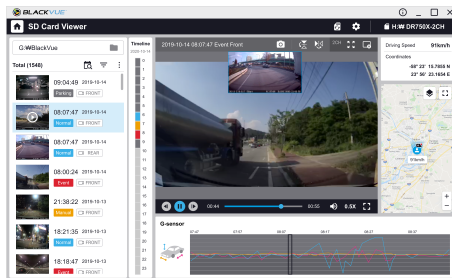

Windows/macOS Viewer



#### Note

- For more information about BlackVue Viewer, go to <https://cloudmanual.blackvue.com>.
- The playback of 4K UHD resolution depends on your computer's hardware and software. Older computers may not support 4K UHD. If you encounter issues please check your computer's video playback capabilities.
- All images shown are for illustration purpose only. Actual program may differ from images shown.

## ► Tips for optimal performance

- (A) For stable operation of the dashcam, it is recommended to format the microSD card once a month.

### **Format using BlackVue App (Android/iOS):**

Go to **BlackVue App** > **⋮** > **Format microSD card** and format the microSD card.

### **Format using BlackVue Viewer (Windows):**

Download **BlackVue Windows Viewer** from [www.blackvue.com](http://www.blackvue.com) > **Support** > **Downloads** and install it on your computer. Insert the microSD card into the microSD card reader and connect the reader to your computer. Launch the copy of BlackVue Viewer that is installed on your computer. Click the Format  button, select the card drive and click **OK**.

### **Format using BlackVue Viewer (macOS):**

Download **BlackVue Mac Viewer** from [www.blackvue.com](http://www.blackvue.com) > **Support** > **Downloads** and install it on your computer. Insert the microSD card into the microSD card reader and connect the reader to your computer. Launch the copy of BlackVue Viewer that is installed on your computer. Click the Format  button and select the microSD card from the list of drives in the left frame. After selecting your microSD card select the Erase tab in the main window. Select "MS-DOS (FAT)" from the Volume Format drop-down menu and click **Erase**.

- (B) Only use official BlackVue microSD cards. Other cards may have compatibility issues.
- (C) Regularly upgrade the firmware for performance improvements and updated features. Firmware updates will be made available for download at [www.blackvue.com](http://www.blackvue.com) > **Support** > **Downloads**.

## Customer Support

For customer support, manuals and firmware updates please visit [www.blackvue.com](http://www.blackvue.com)

You can also email a Customer Support expert at [cs@pittasoft.com](mailto:cs@pittasoft.com)

## ▶ Product specifications (DR770X-2CH LTE):

<b>Model Name</b>	DR770X-2CH LTE
<b>LTE</b>	Built - in 4G LTE module compatible with nano SIM
<b>Color/Size/Weight</b>	Front: Black / Width 137.6mm x Height 43mm / 161g Rear: Black / Width 67.4mm x Height 25mm / 25g
<b>Memory</b>	microSD Card (32 GB/64 GB/128 GB/256 GB)
<b>Recording Modes</b>	Normal recording, Event recording (when impact is detected in normal and parking mode), Manual recording and Parking recording (when motion is detected). * When using Hardwiring Power Cable, ACC+ will trigger parking mode. When using other methods, G-sensor will trigger parking mode.
<b>Camera</b>	Front: STARVIS™ CMOS Sensor (Approx. 2.1 M Pixel) Rear: STARVIS™ CMOS Sensor (Approx. 2.1 M Pixel)
<b>Viewing Angle</b>	Front: Diagonal 139°, Horizontal 116°, Vertical 61° Rear: Diagonal 139°, Horizontal 116°, Vertical 61°
<b>Resolution/ Frame Rate</b>	Front: Full HD (1920x1080) @ 60 fps Rear: Full HD (1920x1080) @ 30 fps * Frame rate may vary during Wi-Fi streaming.
<b>Video Codec</b>	H.264 (AVC)
<b>Image Quality</b>	Highest (Extreme), Highest, High, Normal
<b>Video Compression Mode</b>	MP4
<b>Wi-Fi</b>	Built-in (802.11b/g/n (2.4 – 2.4835 GHz))
<b>Bluetooth</b>	Built-in (V2.1+EDR/4.2)

<b>GPS</b>	Built-in (Dual Band: GPS, GLONASS)
<b>Microphone</b>	Built-in
<b>Speaker (Voice Guidance)</b>	Built-in
<b>LED Indicators</b>	Front: Recording LED, GPS LED, B/W/L (Bluetooth/Wi-Fi/LTE) LED, Front Security LED Rear: Rear Security LED
<b>Sensor</b>	3-Axis Acceleration Sensor
<b>Button</b>	Touch Sensor: Pressing the touch sensor triggers manual recording depending on the firmware settings.
<b>Backup Battery</b>	Built-in super capacitor
<b>Input Power</b>	DC 12V-24V (3 pole DC Plug (Ø3.5d x Ø1.1)) to Wires (Black: GND / Yellow: B+ / Red: ACC)
<b>Power Consumption</b>	Normal Mode (GPS On/Cloud On) : Avg. 470mA/12V Normal Mode (GPS On/Cloud Off) : Avg. 410mA/12V Parking Mode (GPS Off/Cloud On) : Avg. 370mA/12V Parking Mode (GPS Off/Cloud Off) : Avg. 310mA/12V * Actual power consumption may vary depending on use conditions and environment. * Model DR770X-2CH LTE should be used only in circuits that satisfy Limited Power Source. (Maximum power consumption is to be less than 100 VA or 8 A).
<b>Operation Temperature</b>	-20 °C – 70 °C (-4 °F – 158 °F)
<b>Storage Temperature</b>	-20 °C – 70 °C (-4 °F – 158 °F)

<b>High Temperature Cut-Off</b>	Approx. 80 °C (176 °F)
<b>Certifications</b>	Front: FCC, ISED, CE, UKCA, RCM, Telec, RoHS, WEEE, KC Rear: FCC, ISED, CE, UCKA, RCM, RoHS, WEEE, KC
<b>Software</b>	BlackVue Application * Android 8.0 or higher, iOS 13.0 or higher BlackVue Viewer * Windows 7 or higher, Mac Sierra OS X (10.12) or higher BlackVue Web Viewer * Chrome 71 or higher, Safari 13.0 or higher
<b>Others</b>	Adaptive Format Free File Management System

\* STARVIS is a trademark of Sony Corporation.

## Product specifications (DR970X-2CH LTE):

<b>Model Name</b>	DR970X-2CH LTE
<b>LTE</b>	Built-in 4G LTE module compatible with nano SIM
<b>Color/Size/Weight</b>	Front: Black / Width 137.6mm x Height 43mm / 161g Rear: Black / Width 67.4mm x Height 25mm / 25g
<b>Memory</b>	microSD Card (32 GB/64 GB/128 GB/256 GB)
<b>Recording Modes</b>	Normal recording, Event recording (when impact is detected in normal and parking mode), Manual recording and Parking recording (when motion is detected). * When using Hardwiring Power Cable, ACC+ will trigger parking mode. When using other methods, G-sensor will trigger parking mode.
<b>Camera</b>	Front: 8-Megapixel CMOS sensor Rear: STARVIS™ CMOS Sensor (Approx. 2.1 M Pixel)
<b>Viewing Angle</b>	Front: Diagonal 155°, Horizontal 130°, Vertical 70° Rear: Diagonal 139°, Horizontal 116°, Vertical 61°
<b>Resolution/ Frame Rate</b>	Front: 4K (3840 x 2160) @ 30 fps Rear: Full HD (1920x1080) @ 30 fps * Frame rate may vary during Wi-Fi streaming.
<b>Video Codec</b>	H.264 (AVC)
<b>Image Quality</b>	Highest (Extreme), Highest, High, Normal
<b>Video Compression Mode</b>	MP4
<b>Wi-Fi</b>	Built-in (802.11 a.b.g.n.ac)
<b>Bluetooth</b>	Built-in (V2.1+EDR/4.2)

<b>GPS</b>	Built-in (Dual Band: GPS, GLONASS)
<b>Microphone</b>	Built-in
<b>Speaker (Voice Guidance)</b>	Built-in
<b>LED Indicators</b>	Front: Recording LED, GPS LED, B/W/L (Bluetooth/Wi-Fi/LTE) LED, Front Security LED Rear: Rear Security LED
<b>Sensor</b>	3-Axis Acceleration Sensor
<b>Button</b>	Touch Sensor: Pressing the touch sensor triggers manual recording depending on the firmware settings.
<b>Backup Battery</b>	Built-in super capacitor
<b>Input Power</b>	DC 12V-24V (3 pole DC Plug (Ø3.5d x Ø1.1)) to Wires (Black: GND / Yellow: B+ / Red: ACC)
<b>Power Consumption</b>	Normal Mode (GPS On/Cloud On) : Avg. 530mA/12V Normal Mode (GPS On/Cloud Off) : Avg. 470mA/12V Parking Mode (GPS Off/Cloud On) : Avg. 400mA/12V Parking Mode (GPS Off/Cloud Off) : Avg. 340mA/12V * Actual power consumption may vary depending on use conditions and environment. * Model DR970X-2CH LTE should be used only in circuits that satisfy Limited Power Source. (Maximum power consumption is to be less than 100 VA or 8 A).
<b>Operation Temperature</b>	-20 °C – 70 °C (-4 °F – 158 °F)
<b>Storage Temperature</b>	-20 °C – 70 °C (-4 °F – 158 °F)

<b>High Temperature Cut-Off</b>	Approx. 70 °C (167 °F)
<b>Certifications</b>	Front: FCC, ISED, CE, UKCA, RCM, Telec, RoHS, WEEE Rear: FCC, ISED, CE, UCKA, RCM, RoHS, WEEE, KC
<b>Software</b>	BlackVue Application * Android 8.0 or higher, iOS 13.0 or higher BlackVue Viewer * Windows 7 or higher, Mac Sierra OS X (10.12) or higher BlackVue Web Viewer * Chrome 71 or higher, Safari 13.0 or higher
<b>Others</b>	Adaptive Format Free File Management System

\* STARVIS is a trademark of Sony Corporation.

## Product Warranty

- The term of this product warranty is 1 year from the purchase date. (Accessories such as an External Battery/ microSD Card: 6 Months)
- We, PittoSoft Co., Ltd., provide the product warranty according to the Consumer Dispute Settlement Regulations (drawn up by the Fair Trade Commission). PittoSoft or designated partners will provide the warranty service upon request.

Circumstances		Warranty		
		Within the Term	Outside of the Term	
For performance/ functional problems under normal use conditions	For serious repair required within 10 days of purchase	Exchange/ Refund	N/A	
	For serious repair required within 1 month of purchase	Exchange		
	For serious repair required within 1 month of exchange	Exchange/ Refund		
	When not exchangeable	Refund		
	Repair (If Available)	For Defect	Free Repair	Paid Repair/ Paid Product Exchange
		Repeated problem with the same defect (up to 3 times)	Exchange/ Refund	
	Repeated trouble with different parts (up to 5 times)			
	Repair (If Unavailable)	For the loss of a product while being serviced/repaired		Exchange/ Refund
		When repair is unavailable due to lack of spare parts within the component holding period	Exchange/ Refund after depreciation	
		When repair is unavailable even when spare parts are available		
1) Malfunction due to customer fault		Paid Repair	Paid Repair	
<ul style="list-style-type: none"> <li>- Malfunction &amp; damage caused by user negligence (fall, shock, damage, unreasonable operation, etc.) or careless use</li> <li>- Malfunction &amp; damage after being serviced/repaired by an unauthorized third party, and not through PittoSoft's Authorized Service Center.</li> <li>- Malfunction &amp; damage due to the use of unauthorized components, consumables, or separately sold parts</li> </ul>				
2) Other Cases				
<ul style="list-style-type: none"> <li>- Malfunction due to natural disasters (fire, flood, earthquake, etc.)</li> <li>- Expired life span of a consumable part</li> <li>- Malfunction due to external reasons</li> </ul>				

- This warranty is only valid in the country where you purchased the product.



**DR770X-2CH LTE:**



**FCC ID: YCK-BV7LTE / HVIN: DR770X-2CH LTE / IC: 23402-BV7LTE**

**DR970X-2CH LTE:**



**FCC ID: YCK-DR970XLTE / HVIN: DR970X-2CH LTE / IC: 23402-DR970XLTE**

**Contains FCC ID: XMR201605EC25A / Contains IC: 10224A-201611EC25A**

<b>Product</b>	Car Dashcam
<b>Model Name</b>	DR770X-2CH LTE, DR970X-2CH LTE
<b>Manufacturer</b>	Pittasoft Co., Ltd.
<b>Address</b>	4F ABN Tower, 331, Pangyo-ro, Bundang-gu, Seongnam-si, Gyeonggi-do, Republic of Korea, 13488
<b>Customer Support</b>	cs@pittasoft.com
<b>Product Warranty</b>	One-Year Limited Warranty

[facebook.com/BlackVueOfficial](https://facebook.com/BlackVueOfficial)

[Instagram.com/BlackVueOfficial](https://Instagram.com/BlackVueOfficial)

[www.blackvue.com](http://www.blackvue.com)

**Made in Korea**